

# TAPE

RECORDING MAGAZINE

MARCH 1963

1/6

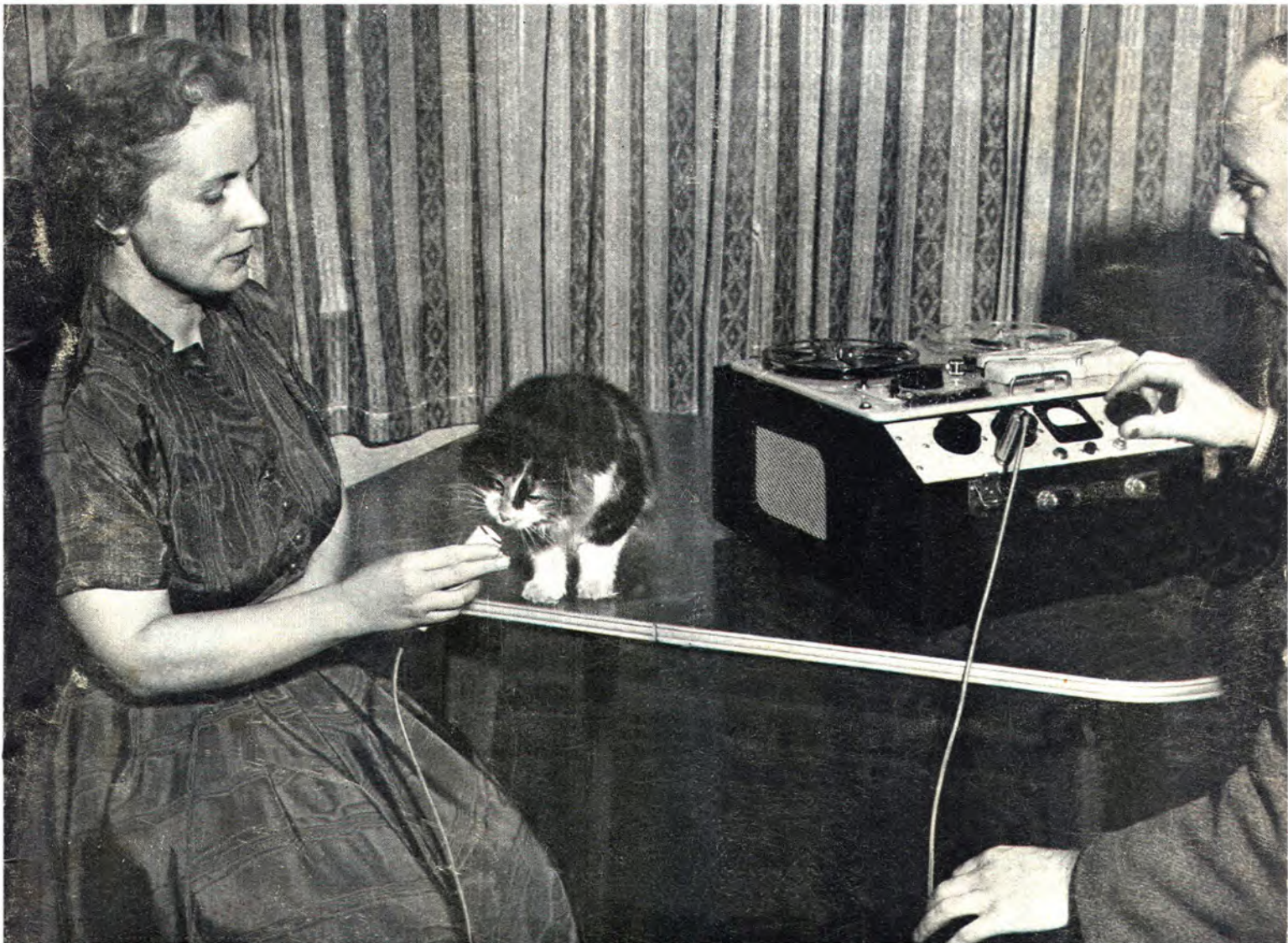

*FIRST AND FOREMOST IN THIS FIELD*

HOW WE MADE  
OUR CONTEST-  
WINNING TAPE

\*

Reviews of tape records

## 18 Months to Pay

	Deposit		18 Monthly Cash Payments		Cash	Gns.
	£	s. d.	£	s. d.		
<b>MAINS TWIN-TRACK</b>						
Truvox R82...	5	15	6	2	17	9 55
Reps. R.10 ...	6	4	0	3	2	0 59
Brenell Mk. 5 ...	7	2	0	3	6	10 64
Brenell 5 (Meter) ...	7	5	0	3	12	6 69
Grundig TK41 ...	8	0	0	3	18	8 75
<b>4-TRACK MONAURAL</b>						
Grundig TK23 ...	4	15	0	2	7	3 45
Truvox R.84 ...	6	4	0	3	2	0 59
Phillips EL3549 ...	6	12	0	3	5	0 62
International ...	7	5	0	3	12	6 69
Reps. R.10 ...	7	5	0	3	12	6 69
Grundig TK40 ...	8	0	0	3	18	8 75
Akai Model 69 ...	8	6	0	4	3	0 79
<b>4-TRACK STEREO/MONAURAL</b>						
Phillips EL3534 ...	9	16	0	4	16	6 92
Phillips EL3536 ...	9	16	0	4	16	6 92
Telefunken 97 ...	10	0	0	4	19	9 95
Grundig TK46 ...	10	12	0	5	3	9 99
Akai M.6 ...	13	13	0	6	16	6 130

Open all day Saturday—  
Friday 6.30 p.m.

## THE RECORDER CO.

features

**GRUNDIG**

**TK.46**

**Price**  
**99 gns.**



**Fully Stereo/Mono: Separate recording and playback amplifiers • 3 heads • Superimposition facilities • Direct tape monitoring • Reverberation control • 2 output stages • 2 Loudspeakers**

We will be pleased to demonstrate this remarkable model. Send for full details.

★ **INTEREST FREE terms**

★ **FREE INSURANCE COVERING YOUR PAYMENTS IN THE EVENT OF SICKNESS OR UNEMPLOYMENT**

★ **FREE DELIVERY**

★ **PART EXCHANGES**

## 12 Months to Pay

	Deposit		12 Monthly Cash Payments		Cash	Gns.
	£	s. d.	£	s. d.		
<b>MAINS TWIN-TRACK</b>						
Elizabethan LZ30 ...	3	7	3	2	10	5 32
Grundig TK14 ...	3	13	6	2	15	2 35
Reps. R.10 ...	6	3	11	4	13	0 59
Telefunken 95 ...	6	3	11	4	13	0 59
Ferrograph 5A/N ...	8	19	0	6	13	10 85
<b>4-TRACK</b>						
Philips "Star Maker" ...	2	16	9	2	2	7 27
Ferguson 3202 ...	3	7	3	2	10	5 32
Philips EL3541 ...	3	15	8	2	16	9 36
Elizabethan LZ29 ...	3	15	8	2	16	9 36
Truvox R64... ...	4	2	0	3	1	5 39
Grundig TK23 ...	4	15	0	3	10	10 45
<b>BATTERY</b>						
Philips EL3585 ...	2	10	5	1	17	10 24
Stella ST470... ...	2	15	0	1	19	2 25
<b>Optacord 412 Battery/</b>						
<b>Mains</b>						
Stuzzi Magnette ...	4	19	0	3	14	0 47
Butoba MT5... ...	7	0	0	5	3	10 66
Ficord 202 ...	7	0	0	5	3	10 66
<b>TRUVOX HI-FI TAPE UNITS</b>						
<b>TWIN-TRACK</b>						
PD.82 Standard ...	4	4	0	3	3	0 £42
PD.87 Stereo ...	6	6	0	4	14	6 £63
<b>4-TRACK</b>						
PD.84 Standard ...	4	12	0	3	9	0 £46
PD.86 Stereo ...	6	6	0	4	14	6 £63

# THE RECORDER CO.

If unable to call, write for free brochure or send deposit now for quick delivery.

(Dept. T) 188, WEST END LANE, WEST HAMPSTEAD, LONDON, N.W.6. Telephone: SW1 4977

for Professional Performance.....

# Tandberg

## STEREO TAPE DECK



- 3 SPEEDS**
- 3 HEADS**
- 4 AMPLIFIERS**
- \*4 TRACK**  
and **2 TRACK**

- High and low level mixer inputs and cathode follower outputs.
- "On and off the Tape" monitoring.
- Sound-on-Sound simultaneous record and playback.

**110 gns**

Booklet of Technical Reviews on request.

## STEREO TAPE RECORDER



- 3 SPEEDS**
- 2 HEADS**

and **2 Power Amplifiers**

- **\*4 TRACK**  
and **2 TRACK**

Send for leaflet.

**BUILD-IT-IN OR CARRY-IT-AROUND!**

- 4 track model 74
- 2 track model 72

(Luggage type carrying case. £7 1s 8d. extra).

**93 gns**

**Tandberg GB**

ELSTONE ELECTRONICS LIMITED,  
Edward St., Templar St., Leeds 2.  
Telephone: Leeds 3-5111 (7 lines)

**You'll be glad you chose**

# **GEVASONOR**

**MAGNETIC RECORDING TAPE**



**GEVAERT LIMITED • GREAT WEST ROAD • BRENTFORD • MIDDX.**



Approved by the manufacturers of the incomparable Ferrograph Recorders whose decks are drilled and fitted to accept the incomparable Bib Splicer.

## RECORDING TAPE SPLICER

Gives you a professional touch! This handy precision tool lets you edit tapes quickly and accurately—with no tape wastage and no post-editing clicks. The Bib Tape Splicer can be mounted directly on the tape deck. It uses all your odd lengths of tape, and pays for itself in tape saving over and over again. Bib value at 18/6!

18/6



### TAPE REEL LABELS

For identifying recorded tapes. Self adhesive—for typing or writing. Space provided for title, composer, date, speed and type of tape. 24 in a packet for 2/6d.



AT YOUR DEALER'S NOW!

In case of difficulty, send remittance to: **MULTICORE SOLDERS LTD.**  
MULTICORE WORKS, HEMEL HEMPSTEAD, HERTFORDSHIRE

## USE YOUR TAPE RECORDER FROM ANY D.C. SUPPLY

You can operate your recorder from a car, caravan or boat battery, or from any D.C. mains supply with a VALRADIO D.C. CONVERTER. These D.C. converters enable you to operate TAPE RECORDERS, etc., for play-back music, telephone conversations and reports whilst on long journeys, in addition to making outside recordings.

Electronic types of converters are also available for 200/250 D.C. with outputs up to 200 watts 50 c/s. from ships' supply or D.C. mains.

Available for practically all makes of recorders, record players, radiograms, amplifiers, etc. with prices ranging from £7 3s. 0d., VALRADIO D.C. CONVERTERS add versatility to your equipment. Valradio and Stereosonoscope are the registered trade marks of Valradio Ltd.



For further details just post coupon below to:

**Valradio**  
LIMITED  
Browells Lane,  
Feltham, Middlesex.  
Tel.: Feltham 4242-4837.



Please send me fully descriptive leaflet, ref: TRM on D.C. CONVERTERS for tape recorders and other equipment

Name .....

Address .....

Make and type of equipment: .....

D.C. volts in:..... A.C. watts out:.....

## MINIMUM SPACE FOR CLEAN CLEAR BASS

### WHARFEDALE W 2

A really compact loud-speaker system giving full range performance on mono and stereo. £27.10.0 in white-wood, £29.10.0. fully finished with a choice of oak, walnut or mahogany veneers.

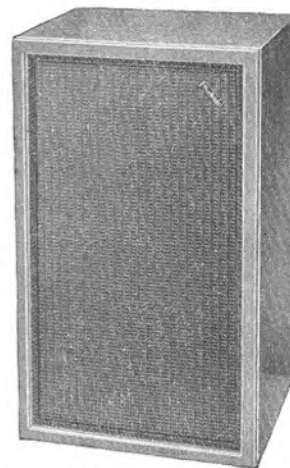

SIZE: 23½" × 14" × 12" WEIGHT: 37lb. complete  
FREQUENCY RANGE: 30/17,000 c/s  
MAX. POWER: 15 watts IMPEDANCE: 15 ohms

As the waveform shows, the enclosure gives distortion-free performance down to 30 c/s with 4 watt input

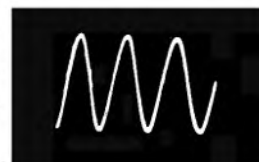

FREE LEAFLET ON CABINET MODELS ON REQUEST



Wharfedale Wireless Works Ltd., Idle, Bradford, Yorkshire  
Telephone: Idle 1235/6 Telegrams: 'Wharfdel' Idle Bradford



SEE  
**ALL**  
MAKES

Hear all makes. At the Tape Recorder Centre showroom you can see, hear and compare them *all*, on the spot. The country's leading specialists in tape recording are there to give you unbiased help in choosing from the country's largest stocks of equipment. At The Tape Recorder Centre there is the model best suited to your needs (and your pocket). And everything else for tape recording, office dictation and hi-fi, plus excellent HP terms. See all makes, hear all makes, at

THE  
**T** **R**  
**C** **TAPE**  
**RECORDER**  
**CENTRE**

**Philips**  
**Elizabethan**  
**Grundig**  
**Ferrograph**  
**Stella**  
**Vortexion**  
**Brenell**  
**Ampex**  
**Tandberg**  
**etc**

82 High Holborn, London WC1. Tel: CHA 7401 ● 75 Grand Parade, Harringay, London N4. Tel: FIT 2316



LOEWE OPTA

# Hi-Fi Tape Recorders

**FOR PERFECTION IN SOUND**

### OPTACORD 403

● Twin Track 2 Speed 3 1/2" and 1 7/8". ● 6" reels giving up to 6 hours playing time ● Flat response 40 to 16,000 CP/S ● Push Button selection for Recording, Gram, Radio and Superimposing ● Rev. Counter, Magic Eye, Tone Control and Volume Control ● Extension Leads, 5 watt Output stage ● P.m. Dynamic Speaker ● A.C. Mains 110V to 240V Selector.

**43 Gns** ▶

### OPTACORD 404

As above but with **53 Gns.**  
4 Track Deck.



### OPTACORD 412

TRANSISTOR BATTERY/ **45 Gns.**  
CAR BATTERY/MAINS RECORDER:

Twin Track Single 3 1/2" Speed taking 4 1/2" Reels ● Wide Band Speaker, Push Button Control, V/Control ● Magic Eye, Tone Control Fast Rewind, ● Radio & Mic. Input Socket, W/ext. lead ● Operating off A/C Mains/batteries or car batteries.

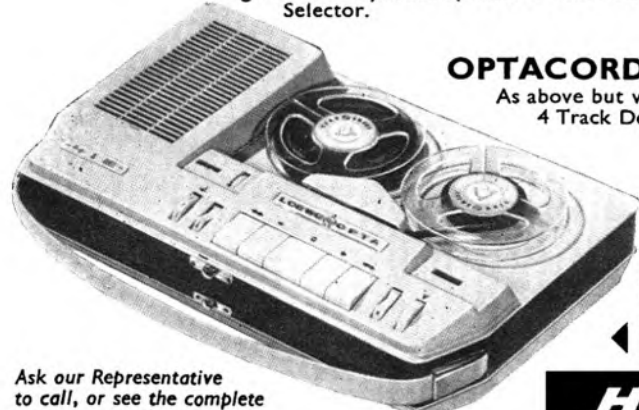

Ask our Representative to call, or see the complete range at our Showrooms.

**HIGHGATE ACOUSTICS**

71/73, GT. PORTLAND STREET, LONDON, W.1

Telephone: MUSeum 2901/6

## TAPE RECORDING YEARBOOK 1962-63

**T**HE latest edition of the "TAPE RECORDING YEARBOOK" is now on the bookstalls. This fifth edition contains the popular "at-a-glance" comparison charts of every currently available tape recorder, microphone, tape deck, and mixer unit together with illustrations, and a valuable miscellaneous accessory guide and magnetic tape price list.

Other contents include a full review of tape developments during the past year; advice on choosing—and using—a tape recorder; tape and cine; copyright; tape records; and a full directory of manufacturers, agents, and tape club addresses.

Simply presented in non-technical language, and including speed and frequency response charts.

**POST NOW to : 7, Tudor Street, E.C.4.**

Please send me.....copy(ies) of Tape Recording Yearbook 1962-63 at 7s. 6d. a copy (including postage), I enclose remittance herewith.

Name .....  
Address .....

*Also available*

### TAPE RECORDING HANDBOOKS

ADVICE ON BUYING A TAPE RECORDER

J. F. Ling  
2/- (2/6 inc. postage)

INTRODUCTION TO THE TAPE RECORDER

Charles Langton  
3/6 (post free)

HI-FI FOR THE MUSIC LOVER

Edward Greenfield  
3/- (post free)

TAPE AND CINE

John Aldred  
3/- (post free)

HOW TO RECORD WEDDINGS

Paul Addinsell  
3/- (post free)

# Take your Ears to the 1963

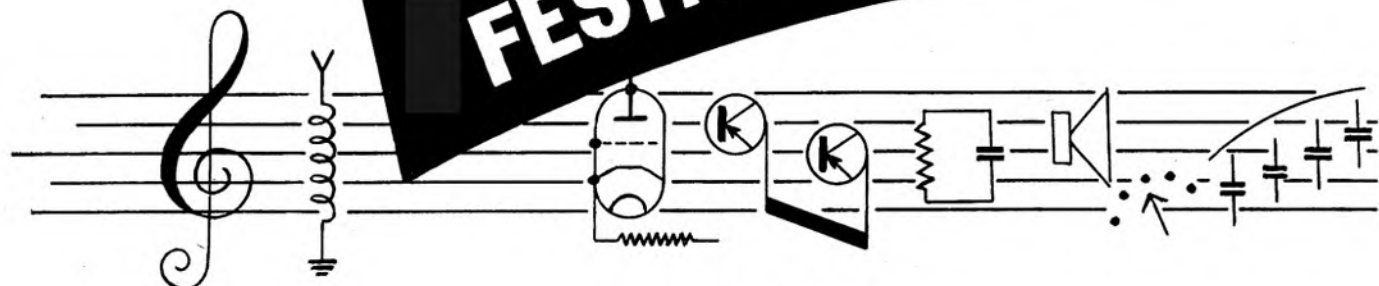

**AT THE  
HOTEL RUSSELL  
RUSSELL SQUARE, LONDON, W.C.1**

<b>THURS</b>	<b>18</b>	<b>APRIL</b>	<b>4-9</b>
<b>FRI</b>	<b>19</b>		<b>11-9</b>
<b>SAT</b>	<b>20</b>		<b>11-9</b>
<b>SUN</b>	<b>21</b>		<b>11-8</b>

★ **TO OBTAIN COMPLIMENTARY INVITATIONS**

*Just ask at your nearest Audio, Radio, Music or Record Shop, or write direct, (enclosing stamped and addressed envelope) to: AUDIO HOUSE, 42, MANCHESTER STREET, LONDON, W.1.*

where you will hear a wonderful array of sound reproducing equipment for the home. At this year's International Audio Festival and Fair the world's finest loudspeakers, amplifiers, tape recorders, pick-ups, discs, tapes and many new and unusual accessories will be continually demonstrated. There is as much for the newcomer to the world of quality sound as for the expert . . . with equipment at prices to suit all pockets. No one whose pleasure is to make harmony in the home, should miss this "Audio Fair".

**MAKE HARMONY IN THE HOME**

# 'The Emitape guide to better recording' by John Borwick

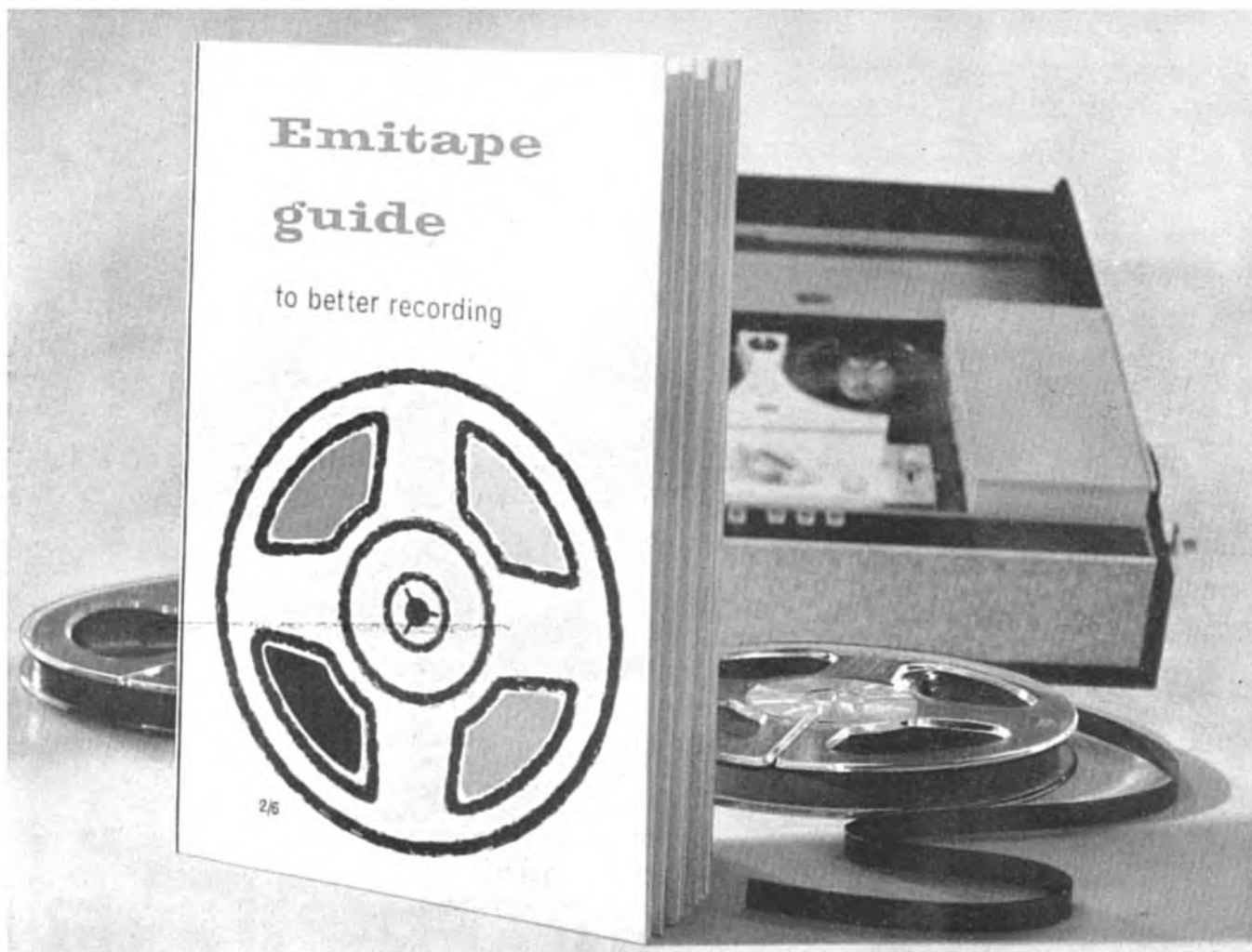

**'No tape user can afford to be without this book'**

PERCY WILSON, TECHNICAL EDITOR OF 'THE GRAMOPHONE'

**Emitape shows everyone the way to better recording.**

First, Emitape's six highly successful Emiguide tapes told you all about sound—through sound.

Now John Borwick caps the series with *The Emitape Guide to Better Recording*—56 pages, filled with ideas, examples and illustrations, giving you all the essen-

tials of tape recording in straightforward language. At only 2/6, this is a *must* which every tape user can afford.

There's no mystery about tape technique when you get Emiguide. Ask your local dealer for a copy of *The Emitape Guide to Better Recording*. Or write direct to E.M.I. TAPE LIMITED, Department EG, Hayes, Middlesex.

E.M.I. TAPE LIMITED · HAYES · MIDDLESEX

Please send me a copy of *The Emitape Guide to Better Recording*. I enclose a postal order for 2/6.

NAME .....

ADDRESS .....

**Emitape**



# BRITAIN'S LARGEST PART EXCHANGE

## SPECIALISTS

- ★ OFFER THE BEST POSSIBLE ALLOWANCE ON YOUR TAPE RECORDER, RECORD PLAYER, RADIO, HI-FI ETC.
- ★ LARGE STOCKS OF MOST UP-TO-DATE MACHINES, 300 TAPE RECORDERS TO CHOOSE FROM

APPOINTED AGENTS FOR:

FERROGRAPH, PHILIPS, BRENELL, REVOX, REPS, AMPEX, SONY, SIMON, AKAI, BUTOBA, COSSOR, ELIZABETHAN, GRUNDIG, REFLECTOGRAPH, TANDBERG, TRUVOX, TELEFUNKEN, UHER, FI-CORD, ROBUK, FERGUSON, VORTEXION, etc.

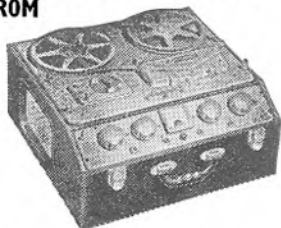

ALL GOODS AVAILABLE ON OUR FAMOUS  
**NO INTEREST TERMS**

10% deposit balance 12 months, 18-24 months terms available  
OUR MAIL ORDER DEPARTMENT COVERS THE WHOLE COUNTRY. FREE DELIVERY. WRITE, PHONE OR CALL FOR A QUOTATION ON YOUR MACHINE. LARGE SELECTION OF USED TAPE RECORDERS

**REW EARLSFIELD Ltd.** Telephone: BALHAM 7710  
266 UPPER TOOTING RD., LONDON, S.W.17.

## TAPE RECORDER COVERS



Smart, waterproof cover to give complete protection to your tape recorder. Made from rubberised canvas in navy, wine, tan, grey and bottle green with white contrasting pipings, reinforced base, handy zip microphone pocket and name panel.

Cossor 1602 ... ..	57/6
.. 1601 ... ..	63/-
Stella ST455 ... ..	63/-
.. ST454 ... ..	57/6
Saja MK.5 ... ..	57/6
Stuzzi Tricorder ... ..	58/-
Saba ... ..	63/-
Wyndor Viscount ... ..	55/-*
.. Victor ... ..	60/-*
Elizabethan Princess ... ..	60/-
.. Avon ... ..	60/-
.. Escort ... ..	57/6*
.. Major ... ..	63/-
.. FT.1 ... ..	66/-
.. FT.3 ... ..	↑
Fi-Cord ... ..	52/6
Korting (4 track stereo) ... ..	63/-
Harting Stereo ... ..	66/-
Fidelity Argyle ... ..	55/-*
Walter 101 ... ..	55/-
Simon SP4 ... ..	63/-*
Clarion (complete with strap) ... ..	52/6
Brenell Mk.5 ... ..	77/-
.. 3 star ... ..	69/-
Minivox ... ..	↑
Grundig TK.5 ... ..	55/-
.. TK.8 ... ..	63/-
.. TK.20 ... ..	52/6
.. TK.24 ... ..	55/-
.. TK.25 ... ..	55/-
.. TK.30 ... ..	60/-
.. TK.35 ... ..	63/-
.. TK.50 ... ..	60/-
.. TK.55 ... ..	63/-
.. TK.60 ... ..	75/-*
.. TK.830/3D ... ..	63/-
.. Cub ... ..	35/-
Telefunken 85 ... ..	60/-*
.. 85 ... ..	65/-
.. 75/15 ... ..	55/-
.. 76K ... ..	55/-
.. 77K ... ..	↑
Philips 8108 ... ..	57/6
.. 8109 ... ..	63/-
.. EL3538 ... ..	63/-
.. EL3542 ... ..	63/-
.. EL3536 ... ..	70/-*
.. EL3515 ... ..	57/6
.. EL3541/15 ... ..	57/6

\* Without pocket  
† Price to be announced

**A. BROWN & SONS LTD.**  
24-28, GEORGE STREET, HULL Tel: 25413, 25412

# TAPE

RECORDING  
MAGAZINE

Vol. 7

No. 3

March 1963

## IN THIS ISSUE

The Editorial View . . . 12

The World of Tape 13

A news digest

How we made our Contest tape 14

H. J. Walding

Don't be afraid to experiment 15

Francis J. G. Hodge

Building a mono-mixer unit 17

Do-it-yourself feature

Test Bench 23

Akai "Multi-four"

Tape Records reviewed 24

Edward Greenfield

Popular music on tape 25

Don Wedge

New Products 26

News from the clubs 29

Tape Exchanges 33

COVER PHOTOGRAPH: "Dialogue for Cats," the "Tape of the Year" in the 1958 British Amateur Tape Recording Contest, was an imaginative treatment of human-pussy relationships with an extraordinary blend of sound effects from both quarters. Producer Basil W. Harley, who also made the "Tape of the Year" in 1957, is seen here with Mrs. Harley, and one of his assistants. His tape took nine months to produce; only four months are left for this year's Contest, see page 14.

"TAPE Recording Magazine" is published on the third Wednesday in the month, by Print and Press Services Ltd., from 7, Tudor Street, London, E.C.4.

"TAPE Recording Magazine" is available by a postal subscription of 20s. per annum (U.S.A. \$3.50) including postage, or it can be obtained at newsagents, bookstalls and radio and music dealers. In the event of difficulty, write to the Publishers at 7, Tudor Street, London, E.C.4.

Back numbers, if still in print, are available at 2s. 6d. per copy for issues up to November 1959, and 2s. per copy for later numbers.

Address all communications

7 TUDOR STREET, LONDON, E.C.4

FLE 1455

**EDITORIAL**

**ADVERTISING**

Editor,  
R. DOUGLAS BROWN

Advertisement Manager,  
MISS PAMELA DURHAM

Assistant Editor, FRED CHANDLER

# THE EDITORIAL VIEW

LAST month I had to report the sad news that the BBC programme "Sound" was being abandoned. This month I can report that things are very different on the Continent. I have received several shocked comments on the BBC decision.

From Copenhagen my old friend Dannefeldt Bothner reports that, after long endeavours, he is getting time on the Danish radio for amateur recordings and he hopes that within a few months there will be a regular programme.

And from Paris, Jean Thévenot, just celebrating the fifteenth anniversary of his programme "Aux Quatre Vents," reports a steadily increasing popularity of this type of programme.

He suggests that a greater emphasis upon the broadcasting of actual recordings made by amateurs would have greater appeal. He cites his own experience. Fifteen years ago, I believe, he had to use a lot of persuasion to get his programme on the air. Now, he says, it is the radio authorities who ask him to provide more. There are, at present, in France, two regular national programmes and three regular regional programmes. And now they have in preparation two new regular programmes for the RTF overseas transmissions.

The formula I would like to see tried in this country would be for a regular programme built around amateur recordings, with the individuals who made them brought along to discuss their approach, their methods and their achievement with a small team of resident experts able to provide conservative criticism and practical assistance.

This would be a quite different programme to "Sound" as we knew it, and it would leave the field clear for a quite separate programme dealing with the wider world of audio at a more technical level.

Readers' ideas on this subject would be of great interest.

\* \* \*

WHILE on the subject of radio, I hear that nearly three-quarters of the radio stations in the United States that are transmitting stereo are now losing money. One of the stations has expressed the view that manufac-

turers of stereo equipment have not done enough to popularise it.

I have always thought myself, as I read the American audio press, that manufacturers have been selling stereo much more aggressively than has been the case here.

\* \* \*

THE detailed programme for the International Study Week for Sound Recordists in Switzerland in July has now reached me. Courses will be conducted in English, French and German. Engineers and lecturers will be present from most of the leading European manufacturers, including Agfa, BASF, Grundig, Saba, Telefunken, Uher, Revox and Nagra.

There will be three main themes for the study programme: "How to arrange an amateur studio," "Accessories for our hobby" and "Interviewing and reporting." On the final day there will be personal contacts between the amateurs and the professionals of Radio Berne.

Those joining the course will arrive in Interlaken on July 14 and the lectures and demonstrations will be on the following six days, so that students can leave on July 21.

Hotel accommodation is available in four classes—de-luxe at 35 Swiss francs per day (including breakfast

and one other meal), class IB at 29 francs, class IIA at 24 francs and class IIB at 20½ francs. (One Swiss franc is equivalent to about 1s. 8d.) If you want full board (i.e., breakfast and two other meals) the prices for the four classes of hotel are 45, 36, 29 and 23½ francs respectively. But the organisers, who are arranging various sightseeing excursions, suggest that it would be better to take only one main meal at the hotel each day, in order to leave oneself free to participate fully.

Interlaken is one of Switzerland's most beautiful holiday centres, situated between the Eiger, the Mönch and the Jungfrau mountains, between the lakes of Thun and Brienz.

Those who would like to attend the course should send a firm booking, not later than April 30, to Fredy Weber, the President of the International Federation of Sound Hunters, at Bürenstrasse 12, Berne, Switzerland.

State clearly the number of rooms required, whether single or double, and in what class of hotel. Indicate whether you want one or two meals per day at the hotel. Give names and address of each individual who will be going.

For those who would like to camp, sites can be booked if M. Weber is asked.

THE EDITOR.

## LAUGH WITH JEEVES

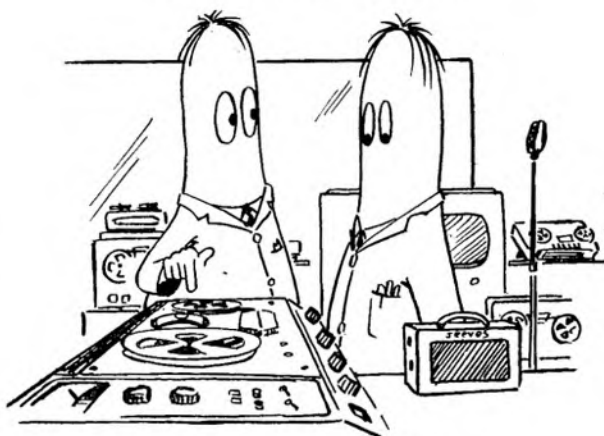

"And this is a built-in bubble to check your recording level."

## BBC RESUME STEREO TESTS

THE BBC have re-commenced their series of field trials of the Zenith-G.E.C. stereophonic system. Using the Wrotham Third Programme transmitter on its normal frequency of 91.3 Mc/s, they are broadcasting three regular morning transmissions. The thirty-minute programmes begin at 10 a.m. on Sundays, and at 11 a.m. on Wednesdays and Saturdays.

Preceding each programme is a five-minute tuning signal, consisting of two tones of different pitch, the lower pitch for the left-hand, Channel A. The signal lasts for four minutes and is followed by one minute with no modulation. A stereo announcement for setting-up purposes begins the actual programme.

The tests will continue until the end of March. During the final few weeks, there will be weekly radiations of test tone transmissions on Wednesdays in addition to the stereo programme material.

# American firm introduces juke-box for tape records

HOUSTON

THE prototype of a multi-selection playback system using a one-inch wide tape which takes twenty tracks has been exhibited here by a local firm, Audio Electronics Incorporated. It was designed for use in record stores to demonstrate single discs and will take 200 individual items.

But being developed is a more sensational application, whereby the unit will be adapted for coin operation and therefore become a revolutionary new type of juke-box.

The unit has been under development for four years by Audio Electronics, a firm specialising in the continuing loop tape cartridge field. Co-operating was Minnesota Mining and Manufacturing, which developed the wide tape.

The special play-back heads required for the unit were designed and manufactured by Ampex. The Houston firm has built special high speed duplicating equipment to process the tape records.

Selection of the 200 items stored on the tape can be accomplished by the special magnetism within six seconds. It involves a photo-electric cell which reads the perforated edge of the tape, trips a relay and the tape comes into position for the selected playing.

The record store version costs about £180. It comes complete with earphone connections and output lines into listening booths, etc.

The proposed juke box version will contain up to 300 items and cost £360.

Audio Electronics also has plans for a home version costing about £110. This would play shorter tapes of the same width. Pre-recorded tapes made up of the equivalent of either one or two disc LP's would be used, costing about 28s. (8s. more than most U.S. disc LP's).

Audio Electronics is discussing availability of records with United Stereo Tapes (the pre-recorded tape subsidiary of Ampex, which handles the product of many U.S. disc firms).

\* \* \*

THE test market launching in St. Louis of the Minnesota Mining and Manufacturing Company's revolutionary automatic tape cartridge record-player (TAPE, January issue) has been a success.

No sales figures were revealed, but obviously 3M was happy with its promotion and has now extended it to the twin cities of Minneapolis and St. Paul. This is 3M's home territory, and there is usually extra good sales because of the local interest in anything 3M does.

By September, the portable cartridge machine should be on sale across the United States in about 25 key markets. By then, 3M will probably have arranged for one of the big console manufacturers to incorporate the deck. The present repertoire of 48 best-selling albums provided by Columbia Records (C.B.S. in Europe) will have been extended, too.

American industry is following 3M developments keenly. It is incompatible with any music reproduction system now in use—discs, video tape and the R.C.A. cartridge. Will it, the industry asks, co-exist with all the others, or will 3M make a bid to replace one or more of them?

## THE WORLD OF TAPE • A NEWS ROUND-UP

### New hi-fi definition in U.S.A.

SAN FRANCISCO

THE Electronic Industry Association has reached a tentative agreement on a proposed new definition of high-fidelity. It sets forth minimum standards of frequency response and power output and will be used as a standard for marketing audio products.

The Federal Trade Commission, a U.S. government agency which directs trading on all levels, had originally asked the electronics manufacturers' body to determine a yardstick of what could be called and advertised as high-fidelity.

The definition has not been made public because it has first to be presented to the government. If accepted, it would be introduced in the summer of 1964 and become effective the following year.

However, it is understood that basically the definition states that to qualify as hi-fi the unit must have a frequency response in the range of 100-8,000 cycles.

The amplifier output rating should be no less than five watts, although this could be spread between two channels.

There was criticism of this on the grounds that it was too loose a definition, but it was finally accepted because of manufacturing difficulties.

The EIA has also been asked to develop a system of measuring and rating loudspeaker quality.

\* \* \*

**A** TWENTY-FIVE per cent increase in sales for all branches of the American magnetic recording industry during 1963 has been predicted by William P. Gallagher, president of the Magnetic Recording Industry Association and vice-president of Columbia Records.

He made it following a survey of members which also showed that 1962 sales were about twenty per cent up on the previous year.

His assessment of the American scene was that four-track stereo tape was now well established. Other reasons contributing to the healthy outlook were increased use of tape in education, the acceptance of FM stereo and the introduction of 3M's new tape cartridge, in which his own firm participates.

A rival, Raymond W. Saxon, vice-president of RCA, has also forecast a good 1963 in the field. He said the tape cartridge-recorder field would enjoy its best year ever. He predicted that these units could account for nearly twenty per cent of the regular recorder market.

RCA has just introduced a new cartridge unit—its fourth—called the Cordon Bleu. It is RCA's first self-contained stereo recorder-playback unit, containing a transistorised amplifier with an extra stereo speaker in the lid of the carrying case. It sells for about £73.

## TAPE TUNER?

A SCHEME to teach learner-drivers the various notes of their car engines using a tape recorder is being operated by a Staffordshire Traffic Officer.

When a lady learner-driver confided that engine noises meant nothing to her, Sergeant Arnold Hill promised to train her ears to engine tones and revolutions. He then spent a day with a Philips battery portable machine recording the sound of good and bad gear changing with their Superintendent's car, a large patrol car, and a mini-car. Recordings were made of the various speeds and tones to show how effective gear-changing can be carried out in a minimum time, and how over-revving causes delay.

The resulting cacophony of tortured gear-boxes together with a symphony of sweetly meshing cogs has already been played over to a hundred students of Sgt. Hill's evening safe driving lectures. On the same tape as the engine noises he has added a running commentary and some sound theoretical instruction.

## CORRECTION

In the special feature on tuners published in our January issue we incorrectly captioned a photograph of three units on page 19. The units illustrated, the SSE/FM, S6BS/FM, and the FM/95 are manufactured by Chapman Ultrasonics Ltd., and are not, as published, by Gramplan Reproducers. We apologise for any inconvenience this error may have caused.

# 1963 BRITISH AMATEUR TAPE RECORDING CONTEST

**A**RE you planning and preparing your entry for the Seventh British Amateur Tape Recording Contest? The 1963 Contest is under way, and there are now four months left to devise, plan, record, and edit your entry. The closing date is **FRIDAY, JUNE 28.**

**N**EXT month we will be announcing the list of judges. Meanwhile, copies of the rules and an entry form are available from 7 Tudor Street, London, E.C.4. Copies may be obtained—free of cost—by filling in and returning the coupon published on page 33 of this issue.

**O**NCE again the Contest will comprise five categories for individual entries. Two additional sections, for schools and clubs, cater for group efforts. As in previous years, there is no set theme. The choice of subject is yours, and the article on the facing page may provide ideas for your entry.

**T**HERE is no entry fee for this Contest. Valuable prizes are to be won, and your tape stands a chance of being the official British entry for the Twelfth International Amateur Recording Contest to be held on the Continent later this year.

# MOSES -Part 2

The producer of the winning tape in the Schools Section of the 1962 BATRC describes how he set about his task

**M**OSES Part 2, was made as a routine feature tape and not produced specially for the British Amateur Tape Recording Contest. The tape was completed early in the March of that year, and when I decided to enter it for the contest I had to edit out 1½ minutes in order to bring it within the fifteen minutes' time limit for the Schools' Section.

I use a tape recorder a good deal at school, particularly for speech training and remedial reading practice, and it is on a feature tape such as Moses Part 2 that the fruits of such teaching may be heard.

The main reason for making these feature tapes is that the children shall learn something as they go along. The final tape is only a goal; it is the journeying that is profitable educationally.

Last year there was no difficulty about the choice of subject for the annual feature tape. In 1961 we had made Moses Part 1, the "cradle story" of Moses, with seven-year-olds, and I was all set to continue the story with the 10—11-year-olds in 1962.

The first concern was the selection of material. Moses Part 1 had been treated in some detail, making a seventeen-minute tape about the cradle story, so I thought it necessary to deal with successive incidents in a similar way. The story was studied in our religious knowledge lessons and after a certain amount of discussion it was decided to include the following scenes: Moses slaying the Egyptian; meeting the daughters of Jethro at the well; the burning bush; the plagues in Egypt and the Passover. All these scenes were to be linked by narration taken almost 'straight' out of the Authorised Version of the Bible. Thus the narration parts were soon fixed; they were sort of milestones between which we had to fit in the dramatised scenes.

I had tried previously to get children to write their own dialogue, in both known and imaginary situations. The drawback of this, I find, is that it seems only common sense that if something is written, then it should be read. Alas, that which is read usually sounds like it.

Even memorising the words is no easy answer, children then tend to read

them out of their memory, there is no life or spontaneity. So, with Moses Part 2, as with similar tapes, I adopted the system of what I term 'natural response dialogue.' As we came to each scene that had to be dramatised I made sure that each child taking part knew two things thoroughly—the character he was portraying, and the action or

By

**H. J. WALDING**

circumstances in which the character was placed. If a child knows those two things then some sort of dialogue will come naturally. We should get a spoken dialogue, not 'read from the memory' dialogue.

With this technique of natural-response dialogue it is difficult to do long scenes. Very soon someone will give a cue line, which, though it may be consistent with his own idea of the character



Alan Stableford presents the Grundig Cup to Susan Hever and Phillip Boxton of Stimpson Avenue C.P. School, Northampton

he is portraying, is unexpected by the child who has to answer such a line, and who consequently finds it difficult to make an immediate reply.

Whenever this happened it was a matter for discussion between the children and myself. Such obvious questions as, "Why did he do that?" "What would he be thinking about then?" "How would he feel when . . . ?" soon sorted things out, and either the scene could be re-acted from the beginning, or the conversation picked up a few lines back and the unwanted portions edited out later.

When it was a matter of emphasis or inflection that was misplaced I would get the child to repeat the line after me, again editing out the unwanted portions later. This did not happen very frequently as it was their own natural dialogue they were using, with their own natural inflections. I must admit that some children do find this technique rather difficult due to either a limited vocabulary or insufficient rapidity of thought and reaction to dialogue. Here, is the educational reason for making these feature tapes, to increase vocabulary and to give conditions for the conscious and thoughtful use of the spoken word.

Two scenes in particular were rather difficult—the burning bush and the plagues. As there were so many plagues I thought it rather unfair to omit any particular variety; it seemed to be a question of all or nothing. But how?

I could imagine the dangers, not to mention the technical difficulties, of attempting to act plagues of boils or lice.

It is very difficult trying to estimate just how much time was spent on each aspect of making the tape, certainly there was far more talk and discussion than anything else. We were never able to follow a recording session straight through without interruption. Frequent halts were necessary in order to discuss even with natural response! I took the easy way out—I wrote nine seven-line verses which were chorally spoken by four children. Even here though, the lines were treated rather freely and changed where ever necessary to fit the children's own particular speech rhythms.

The portrayal of God's voice in the burning bush scene was more difficult. Mystic echoes were 'out' as I was using a machine with only two heads, and it's a rather hackneyed way round the difficulty anyway.

Celestial music, also hackneyed, was 'out' also as I hadn't any, and I am no musician. Eventually I did what surely must make true musicians blanch—I found some vague chords I liked the look of on the piano, played around with them with little skill but much hope for half an hour or so, and then played back the resultant 'music' at half speed. On top of this I superimposed the whole of the burning bush scene. The same technique was used for most of the sound effects. The gong used to heighten (I hope) the tension during the scene of the Passover, was produced by banging a tin can, recording it at  $7\frac{1}{2}$  ips and playing it back at  $1\frac{1}{8}$  ips. The wind noise in the same scene suffered similar treatment.



Pupils of the Stimpson Avenue C.P. School who took part in the production of "Moses-Part 2," seen at the tea party given for them by Grundig (Great Britain) Limited. At their feet is the Grundig TK8 tape recorder which was used to play back the tape during the afternoon's festivities, which was attended by Mr. Alan Stableford, Chairman of the Federation of British Tape Recording Clubs, Miss Brenda Marriott, Publicity Manager of Grundig (G.B.) Ltd., and Mr. R. D. Brown and Fred Chandler of "TAPE." A further treat was given to the children who were taken to see the Northampton Repertory Company's performance of "Babes in the Wood."

## DON'T BE AFRAID TO EXPERIMENT

says Francis J. G. Hodge

**Y**OUR tape recordings should express your personality. If your imagination doesn't seem to be producing the right sort of ideas, here are a few suggestions which should keep you going for a while.

Keeping a diary in sound is fun. The sort of thing that will remind you of current events in years to come. Headlines from the newspapers, together with a summary of the news items. The fashion scene—what the modern young man, or woman is wearing. The popular tunes, the best-selling books and the latest films. Reports of your favourite football team's games. Who is who in filmland. The thousand and one things that make news and you think will be of interest in years to come—if only to settle arguments about what things were like in 1960!

Recording weird and wonderful noises can be fun. Try making some recordings at one speed and then playing them back either faster or slower. Start banging things together, dropping things, rattling and shaking things in front of the microphone, talking in different voices and at different levels. Squeaky doors, drawers that stick or make a noise when you pull them out. These and a host of other similar every day

noises can be used in your experiments.

Tapesponding is, of course, another fascinating side to your hobby. Instead of the usual chatter, and question-and-answer tape why not put a bit of thought into your tapes? You could record local sounds that he isn't able to get on tape at home. If he is interested in dialects you could get around to visiting people who are "natural" dialect speakers.

Ever tried writing a short play or sketch? Most people like acting and, if you are able, it's good fun writing something for them to try their acting abilities out on. It shouldn't be too difficult to prepare a short piece—any everyday incident will do, and the more scope for sound effects in it the better. Last year's *Tape of the Year* winning entry is an excellent example of the sort of thing you can do with a bit of imagination.

Of course children are natural "actors"—most of them don't need a prepared script, they make the "play" up as they go along. You can try your hand at recording them at play—you'll probably finish up with some excellent tapes, they may need a bit of editing done on them to make them run smoothly but you will have some real masterpieces in the end.

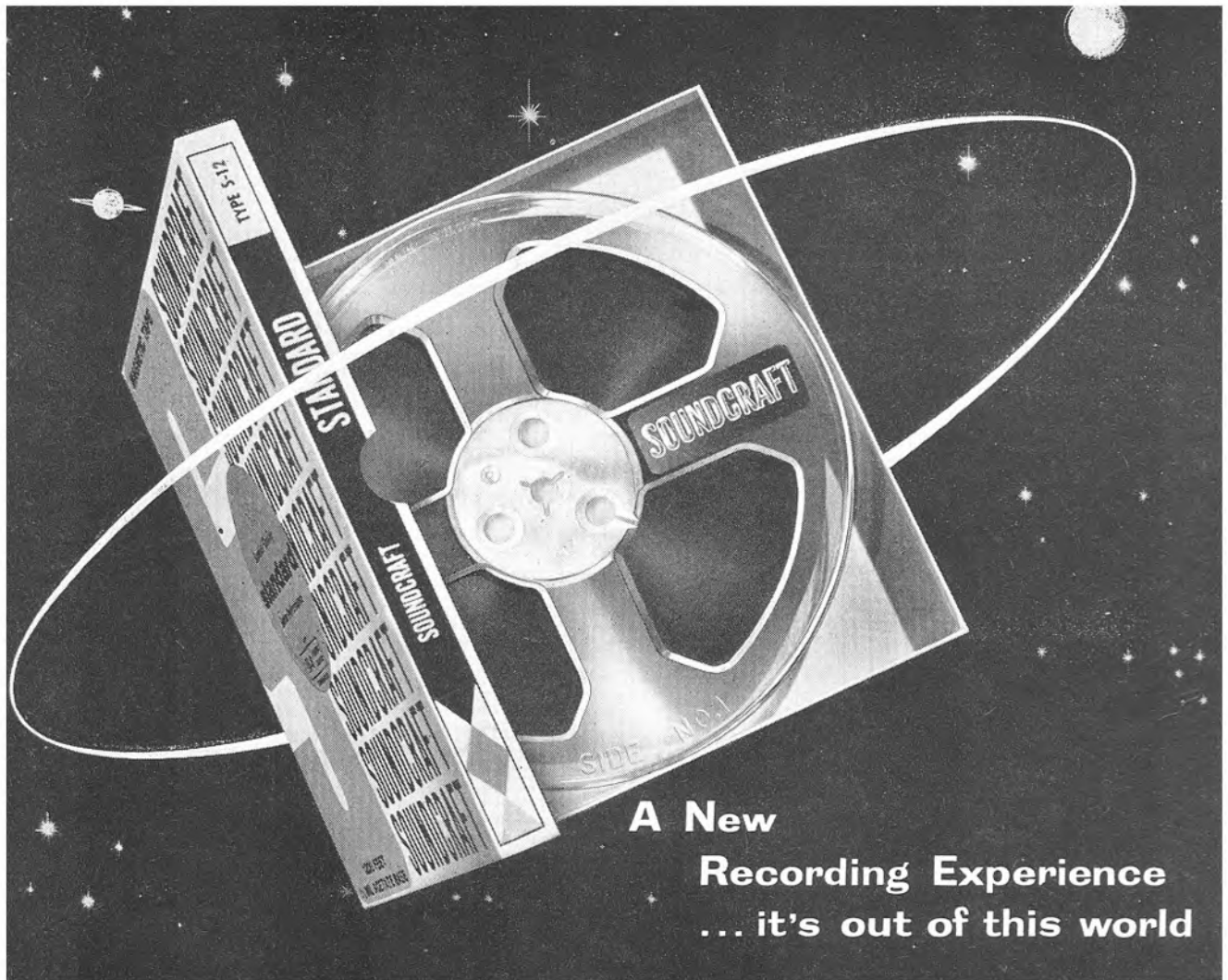

Soundcraft Tapes are so good that they were chosen by the United States Government for use in their weather satellites, Tyros I and II. Still transmitting back to earth, Tyros II is an ever present reminder of the quality and proved ability of Soundcraft Tape. Soundcraft, also, were awarded Hollywood's coveted Oscar for their work in magnetic oxides. Now, this side of the Atlantic, this superlative tape has been sought after by discerning enthusiasts. Already well known British Tape Recorder manufacturers such as **ELIZABETHAN** and **MAGNAVOX** use and recommend Soundcraft for their machines. To do justice to your recording skill your recorder needs the finest tape. Try New Soundcraft tape this week and know the new recording experience that's *out of this world!*

# SOUND CRAFT . . . the tape that speaks from space

On 3", 5", 5½" and 7" 4 spoke reels on DuPont Mylar and Soundcraft tri-acetate. Coloured Mylar Leaders and Trailers. All packs colour coded with timing charts and cellophane sealed for protection.

**SOUND CRAFT MAGNETICS LTD.**, Haddenham, Bucks. Tel. Haddenham (Eucks.) 384 & 422-6 (6 lines). *Manufactured by Reeves Soundcraft Corporation, Connecticut, U.S.A.*

# DO-IT-YOURSELF

By  
R. E. STEELE

# BUILD THIS ADD-ON UNIT FOR THE STEREO-MONO MIXER



The final article in our four-part series describing the construction of a mixer unit capable of handling five stereo or ten mono channels

THE unit described in this article is an add-on unit to convert the Stereo-Mono Mixer (see December, January and February issues) to a ten-channel Mono Mixer. The method of construction is similar to that for the Stereo-Mono Mixer, although it is somewhat more simple in the circuitry.

This extra unit controls the right channel of the stereo inputs. Although one could mix stereo this way (i.e., separate control of each left and each right channel) it is intended to operate as a ten-channel mono mixer. On turning the function switch on the Stereo-Mono Mixer to "mono," the three-way, twenty-four pole switch cuts out the right-hand potentiometers, and switches in the potentiometers in the mono mixer unit. The add-on unit also incorporates monitoring facilities, allowing direct

monitoring of each channel, from the output of the Stereo-Mono Mixer. It is possible to monitor when the units are mixing both stereo or mono. This was achieved by rewiring a pair of headphones so that the "left" and "right" earpieces were connected to the left- and right-hand channels respectively. When mono mixing both of the earpieces are connected together as in normal headphones. These are shown in Fig. 27 (see page 20).

### CONSTRUCTION OF CHASSIS

Basic material requirements are as follows:—

**Aluminium.**—Two pieces of aluminium  $10\frac{3}{8} \times 2\frac{1}{4}$  inches 16 S.W.G. (1/16 inches); one piece  $11\frac{1}{8} \times 4\frac{1}{8}$  inches 16 S.W.G. (1/16 inches); and another piece  $15\frac{1}{4} \times 4\frac{1}{8}$  inches 16 S.W.G. (1/16 inches).

As the chassis construction of the mono mixer is so similar to the Stereo-Mono Mixer it is proposed not to give a closely detailed description for the former unit. It will help, therefore, if a copy of the article containing the "Construction of Chassis" section is kept at hand (December issue).

Cut and shape the aluminium as described below, see also the accompanying drawings. The two  $10\frac{3}{8} \times 2\frac{1}{4}$  inches sheets form the top and bottom covers. Drill the four holes and round off the two corners as shown in Fig. 20. Now take the  $11\frac{1}{8} \times 4\frac{1}{8}$  inches sheet, which will form the front (Fig. 21). It is almost identical to the front of the Stereo-Mono Mixer, but there are less holes to cut. Mark the holes with the aid of a sharp-pointed scriber and dividers, as described in

(Continued on page 18)

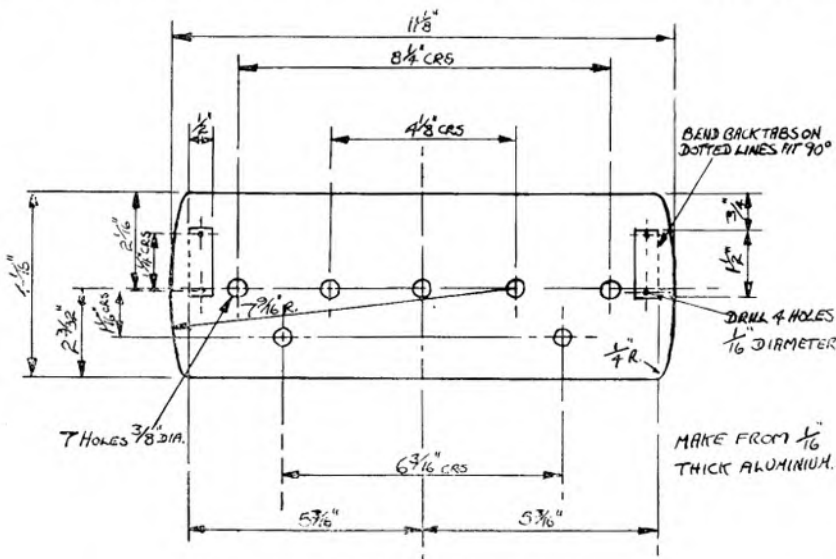

Fig. 21. Front panel of the mono-mixer chassis.

# BUILD THIS ADD-ON UNIT FOR THE STEREO-MONO MIXER

(Continued from page 17)

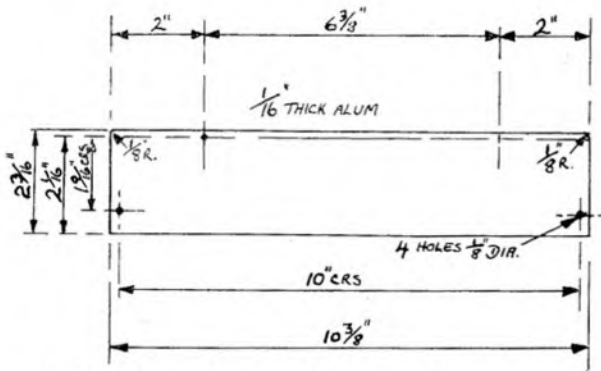

Fig. 20. Top and bottom plates. Two of these are required.

the earlier article. The back and sides are bent up from one piece (Fig. 22). Again this is similar to the previous chassis, but there are no tabs.

After drilling and shaping is complete, clean off all rough edges. First fit the octal socket and the two co-axial sockets into the back using self-tapping screws. These last components should be inside the chassis with the screw points projecting through the back, and the sharp points cut or filed off. The 2BA anchor nut is held in position with the two 6BA nuts and bolts.

Now assemble the front to the back and sides using four self-tapping screws. It will help when driving in these screws if a piece of steel or wood is clamped to the bench. The back of the front panel can then be supported firmly. Place the top and bottom plates in position and mark through the drilled holes in these plates the positions of the tapped

holes in the sides and back. Drill 1/16-inch diameter holes in the marked positions and attach the top and bottom with self-tapping screws. The volume control shafts will have to be shortened before they are fitted.

First temporarily fit one of the potentiometers in the chassis with the plastic panel (or a packer of equivalent thickness) in position. Now press on one of the knobs and measure the distance from the knob to the plastic panel. This amount plus 1/16-inch will have to be cut off from each shaft. The two jack sockets are fitted on temporarily (the plastic panel is left off until the unit is completely wired, to prevent scratching).

Wire the components as shown in the circuit diagram (Fig. 23). Check the potentiometer connections so that the volume is off when rotated to the left, and not vice versa. When wiring is completed the unit should be connected to the Stereo-Mono Mixer for testing. The

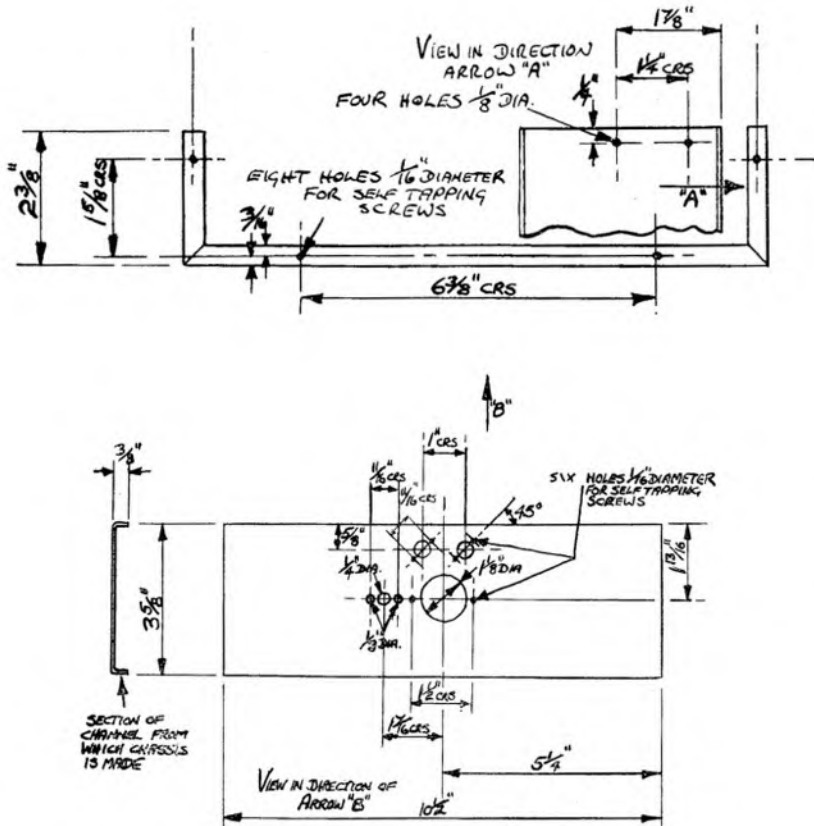

Fig. 22. Back and sides of the mono-mixer chassis.

**PARTS LIST FOR THE MONO MIXER RIGHT CHANNEL**

Five potentiometers—500K ohms log—single.  
 Five Resistors 220K ohms half-watt HS.  
 Two Panel jacks—Bulgin Cat. No. J11.  
 One Chassis-mounting socket—McMurdo ref. No. B/8U.  
 Two "Clix" coaxial sockets and plugs.  
 Five knobs (as for Point One Stereo pre-amplifier).

Connecting wire (for internal wiring), red white and blue.  
 Eighteen self-tapping screws—3/16 inches long (under head).  
 One 2BA Anchor bolt (11/16 inches crs) between fixing flanges. (If these crs vary then the holes in the chassis will have to be modified.) Two 6BA round-headed bolts and nuts (for above).

A number of readers have written requesting information on the availability of the parts required for the construction of the Stereo-Mono and Mono-Mixer Unit. The author has therefore supplied the following addresses.

T.R.S. Radio Component Specialists, 70, Brigstock Road, Thornton Heath, Surrey, for resistors and capacitors (all values), tag board, valves (EEC 83), Valve bases (B9A, skirted), Shaft assembly and six four-pole three-way wafers for the 24-pole rotary switch, "Clix" plugs and sockets, single and ganged potentiometers, and Lilliput lamps.

Webb's Radio, Soho Street, London, W.1, for Chassis mounting plugs (C8/USP) and sockets (B8/U), other plugs and covers (L8/USP), and other sockets and covers (LS/USP).

A. F. Bulgin & Co. Ltd., Bye-Pass Road, Barking, Essex, for panel jacks (J12), On/off rotary switch (S253 or S256), and Lilliput lamp-holder (LES 102).

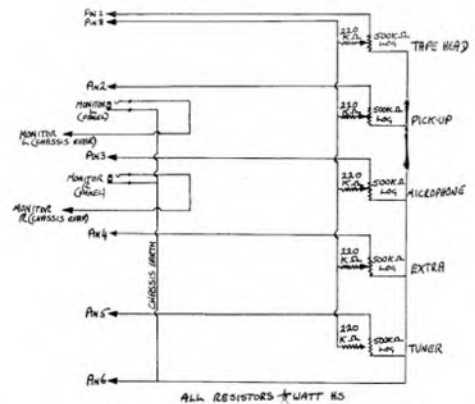

Fig. 23. Circuit diagram of the mono-mixer.



# BUILD THIS ADD-ON UNIT FOR THE STEREO-MONO MIXER

## CORRECTIONS

**D**UE to a misprint in our January issue a number of words were omitted from the first sentence in column one of page 22. This should read: "Connect all 220 K ohms anode and interaction resistors. The 15M ohms resistors were made from one each of a 10M ohms and a 5M ohms, as the 15M ohms were not available."

There was also an error by the author with regard to Figure 6 in the January issue. The wiring chart should show a strapping connection from Wafer 1, Switch 3, Pole 3, to Wafer 1, Switch 4, Pole 3; and from Wafer 3, Switch 11, Pole 3, to Wafer 3, Switch 12, Pole 3.

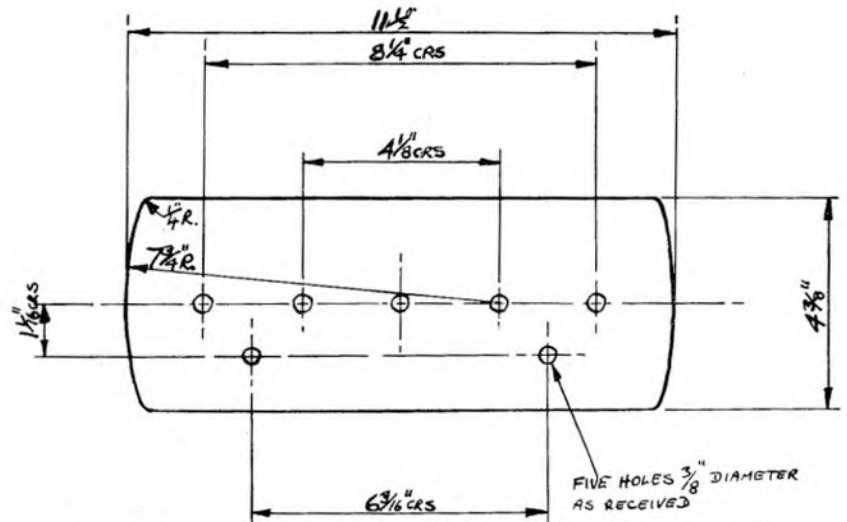

Fig. 24. Drilling the plastic panel for the mono-mixer. Full dimensions are given for the reader who wishes to make his own panel from a  $\frac{1}{8}$  in.  $\times$   $\frac{5}{32}$  in. thick plastic sheet.

connections to pins No. 7 on the two octal sockets, on the Stereo-Mono Mixer, marked "Pre-amp left" and "Pre-amp right" should be made, and also the two leads on the pre-amp left and pre-amp right marked "Monitor."

## THE PLASTIC PANEL

This is also similar to the Stereo-Mono Mixer panel. It is, in fact, exactly the same as Leak's Point One Stereo Pre-amp panel. If it is not possible to obtain a drilled panel, then the panel will have to be made from plastic sheet or perspex. The full dimensions are given in Fig. 24.

The edges are rounded off on the front face only. This is best achieved by first using a very sharp plane to remove the corner and then using fine grades of "wet or dry" emery down to the finest grades obtainable (grade 0000).

This should be used with plenty of water. Great care should be taken to prevent scratching the front of the panel. This is made easier if the emery paper is used on a flat block. The final finish is obtained by several applications of metal polish.

## THE DECORATIVE PANEL

The material required for the decorative front panel includes: Transparent Film 12 x 5 x .005 inches thick; three sheets— $\frac{1}{2}$  inches (block letters) transfers—white; and white, gold and maroon paint.

(Continued on page 20)

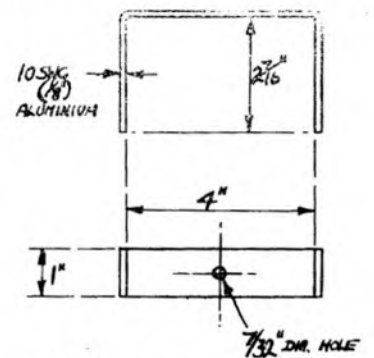

Fig. 26. The clamping bracket for the mono-mixer.

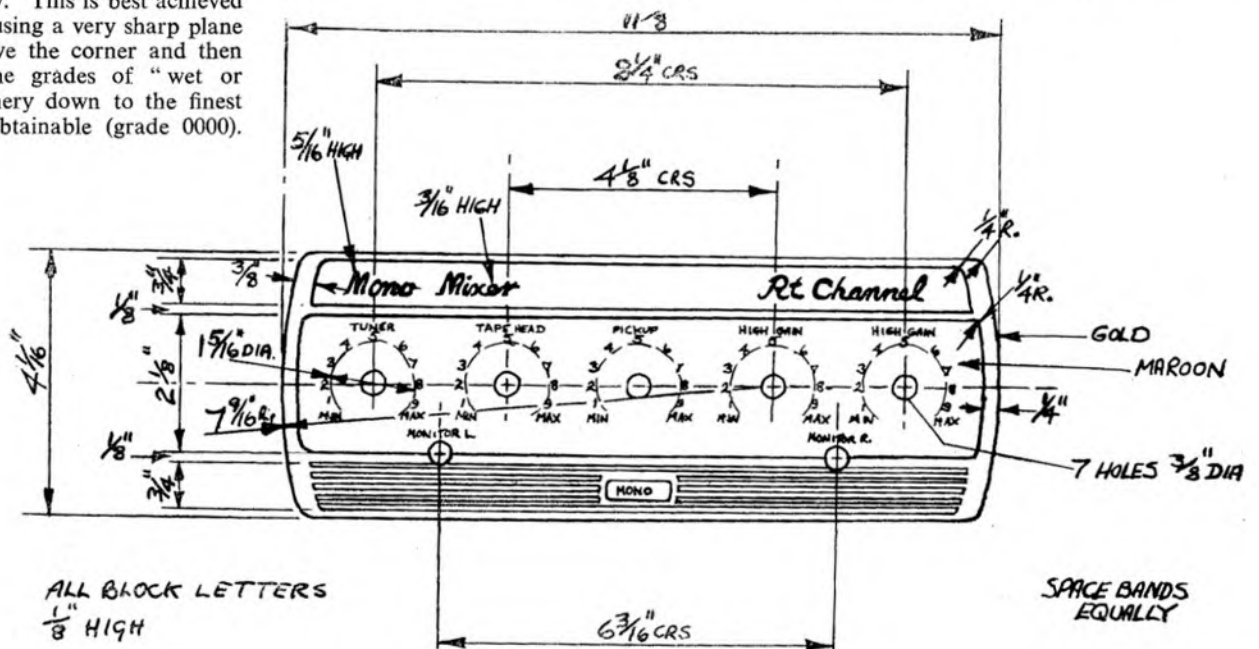

Fig. 25. Decorative panel for the mono-mixer.

# BUILDING A MONO-MIXER

(Continued from page 19)

This will require very little explanation for again the process is very similar to that for the Stereo-Mono Mixer. The same procedure is followed except for the lower "Mono" frame. In the former, the frames were left unpainted to enable the indicator lights to be seen, but the Mono Mixer does not need to be left blank, as there are not any indicator lamps. The dimensioned sketch of the decorative panel is shown in Fig. 25. This will have to be reproduced to full size (if a copy was not obtained with the Stereo-Mono Mixer panel sketch).

When the paint is dry the decorative panel should be trimmed. The

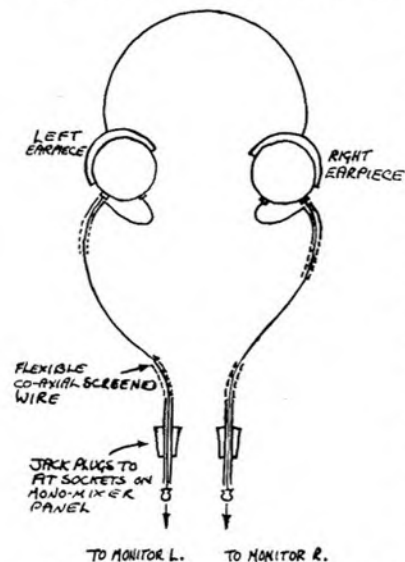

Fig. 27. Modified connections to earphones used for monitoring on the Stereo-mono and Mono-mixer.

panel nuts holding the potentiometers and jacks in position are now removed and the decorative panel carefully placed over the shafts. The plastic panel is fitted on top of the decorative panel and the nuts replaced.

## CLAMPING BRACKET

This is shown in Fig. 26 and is identical—except for the length of the legs—to that shown in the Stereo-Mono Mixer article. A second fixing bolt will be required to hold the unit in position.

## HEADPHONES

Any medium or high impedance phones will be suitable. The modification to the wiring is shown in Fig. 27.

The difficulties of installing stereo equipment in an average living-room can be solved by various means. Here, C. S. ROGERSON describes how he overcame the problem by an ingenious method.

ONE of the greatest problems facing the stereo enthusiast, even more so than his monaural counterpart, is finding a solution to installing stereo equipment in the living room.

Some while ago I was faced with this problem. A great deal of thought regarding speaker placing was required, and I eventually hit on the following idea.

Seeing a lot of space going to waste in the convertible bed settee in my lounge room, I merely removed the rear wall of the storage compartment and inserted a sloping panel large enough to contain two eight-inch twin cone wide range loudspeakers (see illustration).

These are totally enclosed, the trapped air volume giving sufficient compliance not to seriously affect the bass resonance. A felt partition separates the air volume occupied by the two speakers.

The angle of the speakers was dictated by the need to allow the back rest of the settee to be lowered for normal use with the occasional guest. However, this angle and the normal spacing of the settee from the wall gave the correct spread of sound from the wall.

I have also a bass reflex box which was used for hi-fi reproduction before going over to stereo. This box is on castors and now does duty as an extension loudspeaker or as a fill-in to give extra wide spread of sound. The quality of reproduction of the settee loudspeaker compares more than favourably with the bass reflex arrangement and it has solved, for me at least, the problem of too much furniture.

The carpentry work was completed in one afternoon, cost only a few shillings, required no polishing operation and the result met the whole-hearted approval of the little lady.

Of course, guests occupying the settee feel as if they are sitting with their backs to the "stage." However,

there are enough chairs in the room which are generally used for serious listening. Nor is the listening position otherwise critical. This is no doubt due to the effectiveness of the plaster wall as a reflector which results in a true "curtain of sound."

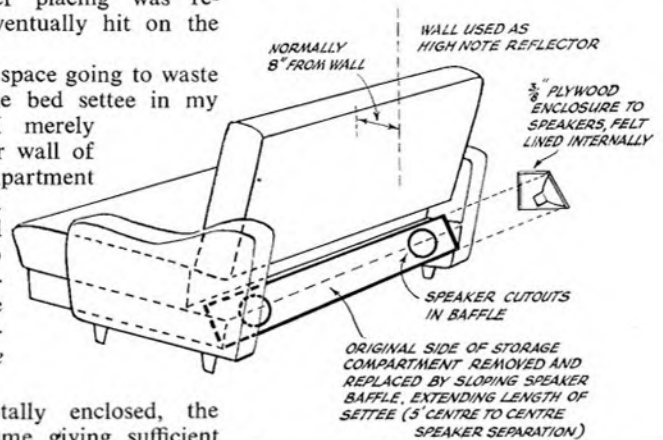

## AMERICA'S ONLY TAPE RECORDING MAGAZINE

Since 1953, this magazine has totally been devoted to tape recording. In addition to its timely articles, our columns also feature:

- Tape Reviews
- New Products
- Industry News
- Questions and Answers
- Feedback (letters from readers)
- Crosstalk (an editorial)
- Club News (tape correspondence clubs)
- Tape in Education
- Book Reviews

A one year subscription, including overseas postage, \$4.75

**TAPE RECORDING**

SEVERNA PARK, MARYLAND, U.S.A.



# NEW FI-CORD 202

**PORTABLE  
BATTERY/MAINS  
RECORDER**

*so much in so little space*

**The FI-CORD 202 offers all these features:**  
 2 speeds— $7\frac{1}{2}$  and  $3\frac{3}{4}$  • Standard 4" spools • Vu-meter • Fast forward wind • Fast rewind • Resettable counter • Manual and automatic volume control • Built-in loudspeaker • Extension speaker socket • Low and medium input sockets • Socket for remote control • Safety record switch • Easy-load battery cassettes • Battery warning lamp • Mains input.

FI-CORD 202, the new portable battery/mains high fidelity tape recorder, has been developed after years of exacting tests in the Fi-Cord laboratories. It is a worthy successor to the famed FI-CORD 1A, used internationally by broadcasting companies during recent years.

FI-CORD 202 is for the most exacting professional and equally for the enthusiastic amateur demanding the highest professional standards. It incorporates all the practical advantages of a full-size recorder in a small, light-weight machine.

FI-CORD 202 gives you high fidelity recording at your fingertips—whenever you wish, wherever you go.

**AND the FI-CORD 202 weighs only  $6\frac{1}{2}$  lb, measures  $9" \times 6\frac{1}{2}" \times 4\frac{1}{2}"$ .**



**Price: 66 guineas**, including long life mercury batteries and tape.

**ACCESSORIES INCLUDE:**  
 Carrying case, choice of microphones, power packs for mains and car.

Write for fully illustrated brochure and address of nearest stockist to:

**FI-CORD INTERNATIONAL**  
 40a Dover Street, London W1. HYDe Park 3448

# The Berean Forward Movement

(NON-SECTARIAN  
NON-DENOMINATIONAL)

600 reliable expositions of the Bible available on tape (3½ ips) at very low loan charges (free to the blind and infirm).

Invaluable to *all* Christians, from teachers to tyros; for Bible Study groups or private meditation. Supporting literature also available.

Send for free, complete list to B.F.M. "Eastgrove," Marsham Way, Gerrards Cross, Bucks.

## AUTOMATED SLEEP-SUGGESTION

- WHAT IS SLEEP-SUGGESTION?
- HOW DOES IT WORK?
- HOW CAN IT BENEFIT YOU?

SEND NOW for FREE BROCHURE for up-to-the-minute information on this vital subject

EDUCATIONAL RECORDINGS LTD.  
Dept. B, 21 Bishop's Close,  
Church Lane, London, E.17

## BRITAIN'S FINEST TAPE DECK

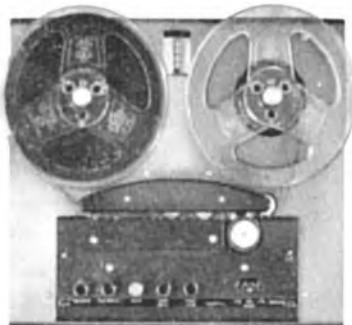

This is not merely our claim—it is the considered judgment of many leading experts. And now, under our 1963 production programme, there will be more PLANET tape decks available.

- ★ The U1 deck has been designed to give a long trouble-free life and exceptional performance. That is why it is used by many professional studios and why it is the ideal deck for the serious amateur.
- ★ Now we introduce the U1/15, which is identical to the U1 except that it operates at 3¾, 7½ and 15 ips. Improved production facilities at our new factory enable us now to accept orders for early delivery.

Write for illustrated brochure and independent test reports to:

### PLANET PROJECTS LTD.

Goodman Works, Belvue Road, Northolt, Mddx.

## TAPE RECORDING AND HI-FI

By the Editor of TAPE Recording Magazine

*The best available introductory guide*

160 pages, 40 illustrations. 13s. 3d. (including postage) from Tape, 7, Tudor Street, London, E.C.4

THE WAL D-MAG, head demagnetiser, long nylon covered probes £2 10s. 0d.  
WAL GAIN transistorised pre-amplifiers, Mono £5 10s., Stereo £7 10s. and Hi-Gain (latter C.C.I.R. equalised) - £7 16s.  
THE WAL BULK Eraser - £7 18s. 6.  
Available from all leading dealers. (Wholesale include T.D. & B. London, and A. C. Farnell, Leeds).



WELLINGTON ACOUSTIC

LABORATORIES LTD., Farnham, Surrey (Fnhm 6461)

H. D. KIRK

# Stereolectrics

LIMITED

Have the facilities for you to hear the finest in High Fidelity Sound Equipment

Tape

Disc

Radio

with a varied selection of furniture to house your choice

Specialists in High Fidelity

Phone: 23093

150 HIGHER BRIDGE STREET

**BOLTON**



# be an angel

*write* to us for a free specimen copy of RECORDS AND RECORDING or MUSIC AND MUSICIANS—the illustrated monthly magazines which are *absolutely devoted* to records and music



## THE AKAI "MULTI-FOUR"

**P**RODUCED in Japan by one of the foremost firms in the tape recording field, the Akai "Multi-Four" is an example of simple but elegant design. The machine will record and reproduce both mono and stereo using the four-track system. It will also play half-track stereo recordings. An ingenious head shifting mechanism aligns the two quarter-track heads to scan the centre portion of each half-track, thus ensuring optimum performance.

The normal recording and reproducing speeds are  $7\frac{1}{2}$  and  $3\frac{3}{4}$  ips, with an additional facility of playing back at 15 ips for rapid dubbing. The machine will accept up to seven-inch spools, giving a recording time of one hour stereo, or two hours' mono, at  $7\frac{1}{2}$  ips on standard tape, and double this time at  $3\frac{3}{4}$  ips. Fast forward and backward wind are provided, this

function has been selected it is impossible to switch to another without first returning the controls to the "off" position, thereby preventing accidents. A further safety catch is provided, preventing accidental switching to the "record" position.

Instant "stop" and "start" controls are also provided, and these can be used to halt the tape whilst recording level adjustments are being made. A further control on the top of the head block

**By H. Burrell Hadden**

gives mono and stereo track selection. Speed selection for  $7\frac{1}{2}$  and  $3\frac{3}{4}$  ips is by a control situated between the reels. An additional capstan is provided to give the 15 ips.

The two amplifier units are basically identical, having three main controls. These are, a level control, operating both on record and playback; a switch giving equalisation for  $7\frac{1}{2}$  and  $3\frac{3}{4}$  ips; and, mounted concentrically with this switch, a tone control operating on playback. Each amplifier has its own VU meter for

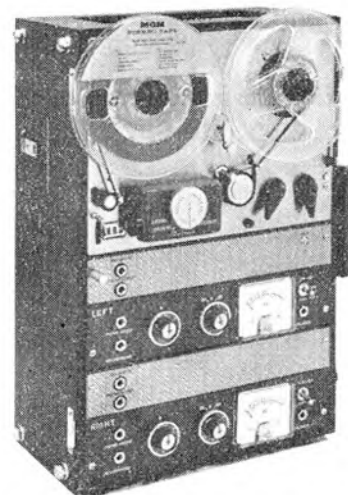

and these leads are carried in a small plastic accessories' case which measures  $9 \times 4\frac{1}{2} \times 4\frac{1}{2}$  inches. The recorder mains lead is carried in a small compartment on the side of the machine.

All the above equipment is included in the basic price of 130 guineas. In addition to the recorder provided for review, we were supplied with a pair of loudspeakers styled to match the recording machine for stereophonic reproduction. These loudspeakers are designed to clip together for easy carrying, and are provided with leads for connecting to the machine. Each section contains a wide range moving coil loudspeaker unit, a switch being provided giving "flat" and "bass" positions. The speakers cost an extra 30 guineas.

The equipment was given the usual series of measurements and practical tests. The record replay frequency response characteristics at  $7\frac{1}{2}$  and  $3\frac{3}{4}$  ips are shown in the accompanying graph. These were for the "flat" position of the tone controls, and are very satisfactory. Considerable variation by both bass and treble could be obtained by the use of the tone controls, so that most requirements could be catered for. Wow and flutter were of such a low value that good piano recordings could be made at  $3\frac{3}{4}$  ips, a difficult test. In all respects the machine met the manufacturer's specification.

Some stereo tape records were played using the accessory extension loudspeakers. Although reproduction from these was very good, considerably better than the internal monitoring loudspeaker as would be expected, it was not outstanding, and not really worthy of the reproduction possible from the machine.

However, at an effective price of 15 guineas each these portable loudspeakers are still good value for money.

No real complaints could be made about this machine; perhaps the rewind time is rather long, and it is a pity that there seems to be no way of using the internal loudspeaker to monitor the second track for stereo. With these very slight reservations, I can thoroughly recommend this machine as a very good buy at 130 guineas.

**Agents: Northgate (Cameras) Limited, 119-125, Wardour Street, London, W.1.**

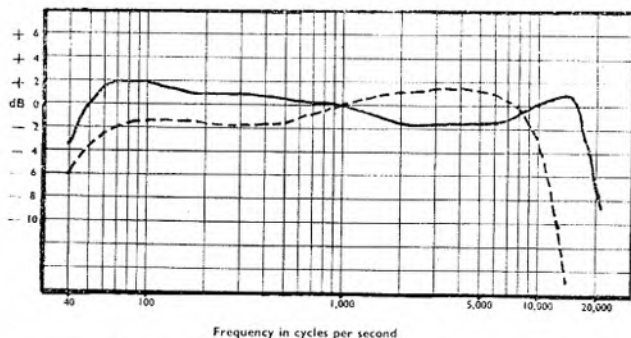

**Frequency response of the Akai "Multi-Four" tape recorder.**

**Record / playback at  $7\frac{1}{2}$  ips—**

**Record / playback at  $3\frac{3}{4}$  ips - - - -**

operation being somewhat on the slow side, taking two and a half minutes for a seven-inch reel of standard tape.

The machine comprises three main units, the deck, and the two separate record/replay amplifiers, all mounted in a grey plastic-covered wooden case. The general appearance is most attractive, and the machine would not look out of place in a professional recording studio. The dimensions of the recorder, which stands upright, are  $20\frac{1}{2}$  inches high, 14 inches wide, and  $8\frac{1}{4}$  inches deep. It weighs  $46\frac{1}{2}$  lb.

The tape transport is driven by a single hysteresis synchronous motor and the deck unit contains all controls associated with the movement of the tape. Two interlinked controls provide for "play," "record," and "fast wind," and once one

recording level indication, and also carries input and output jack sockets.

Inputs for radio/gram and a microphone are provided on each channel, plus head, pre-amplifier and loudspeaker outputs. A single monitoring loudspeaker for mono only is provided in the recorder case. This is automatically disconnected when external speakers are plugged in.

Two moving coil microphones are provided, and using these some very good stereo and mono recordings were made. Two input leads are provided in addition to the microphones for radio or gram connections. These, very sensibly, have jack plugs on one end and crocodile clips on the other. This method of connection is very quick, and avoids the necessity of changing plugs to fit different equipment. The microphones

# TAPE RECORDS REVIEWED

**AARON COPLAND.** *Symphony No. 3.* London Symphony Orchestra conducted by Aaron Copland. World Records (TCM 34), 3½ ips, mono. 29s.

Hot favourite to be considered the greatest work ever written by an American composer is Copland's Third Symphony, a magnificent work, immediately memorable and attractive but toughly argued and essentially American in every bar.

In this work Copland achieved triumphantly what almost every American composer before and since has been trying to do. So cosmopolitan a country has no ready-made national idiom to work from: Copland and his colleagues created one with roots in what comes closest to new world folk traditions—the ho-down hill-billy style and the “wide open spaces” style of the West. But where other composers have often been a little self-conscious in their Americanism, Copland sounds completely spontaneous. Ironically, perhaps, he is not himself a product of the wide open spaces but a purely-bred Jew from Brooklyn.

That biographical fact does not alter the greatness of the music which has come from his pen, and most incontrovertibly of all this magnificent symphony. The first movement has a broad strong sweep, lyrical and symphonic at the same time; the scherzo has the punch of a ho-down; the slow movement is most moving in its hushed beauty; the finale after opening with what Copland originally wrote as a “Fanfare for the Common Man” goes on joyously with jazzy off-beat rhythms that stand firmly rooted in the new American tradition.

Copland himself is a fine conductor of his own work, particularly when he has an orchestra so superbly responsive and brilliant as the London Symphony. It is some tribute to their skill that they were chosen, and the recording by Everest is one of the very finest I have heard on 3½ ips tape.

“AT THE DROP OF A HAT.” Michael Flanders and Donald Swann. Parlophone (TA-PMC 1033), 3½ ips, mono. 35s.

This is perhaps the most successful record of a stage revue ever made. It is simply a tape of a live performance made early in the show's fabulous run at the Fortune Theatre. At first the audience reactions seem a little obtrusive, but from long experience I know how much they add to the atmosphere. In fact when the stereo version came out on disc I found myself irritated with a rather colder audience than I had got used to in this mono version. There is also the advantage here of an extra number, *Kokoraki*, an interminable Greek song about farm-yard animals, made delightful not only by Swann's charm but Flanders's gruff humour as a commentator.

I assume that most of the numbers are well enough known by now. They have become classics of the revue stage—the

## THE CLASSICS

by Edward Greenfield



song about the London bus, the Gnu song, the Reluctant Cannibal, Madeira M'dear, the Hippopotamus, My favourite I think is the song about the honeysuckle and the bindweed, spiralling in opposite directions, touching at the very moment of its comic pay-off. But best of all for hi-fi fans, the *Song of Reproduction*, a masterpiece of script-writing by Flanders, wickedly on target.

The box says inaccurately that this was the final performance at the Fortune Theatre on May 2, 1959. In fact, as I have said, it was an earlier one, recorded in mono only.

**BEETHOVEN.** *Symphony No. 2.* London Symphony Orchestra conducted by Josef Krips. Piano Sonata No. 30, Opus 109. Ernst von Dohnanyi. World Records (TT 193), 3½ ips, mono. 29s.

Another in Krips's unobtrusively excellent series of the nine Beethoven Symphonies, and the first tape version of the work available here. It is highly recommendable with a straightforward approach, sensible speeds and good recording. The coupling is in some ways even more fascinating. The recording was made by Dohnanyi (better known as the composer of the Nursery Variations) not long before he died in 1960 when he was well over eighty. For an octogenarian this is an amazing performance, dramatic and confident in a way that he did not always achieve in recording his own works. Naturally it does not follow modern ideas of Beethoven style. It could hardly be farther removed from Krips in following not a straightforward approach but the old romantic tradition. As well as making free with the rhythm Dohnanyi seems strangely reluctant to play really softly, but the whole is a complete and vivid experience. It convinces me once again that spontaneity is far more important than any stylistic considerations if one is to enjoy the result.

Musically the coupling is well chosen and imaginative, too. The vigour of the early symphony balances the tenser vitality of the last-period sonata.

The tapes reviewed this month are available from the following addresses:—

“Capitol,” “Columbia,” “H.M.V.,” and “Parlophone,” E.M.I. Records Ltd., 20, Manchester Square, London, W.1.

World Record Club, Box 11, Parkbridge House, The Little Green, Richmond, Surrey.

“CAN-CAN.” Sound Track with Frank Sinatra, Maurice Chevalier, Shirley MacLaine, etc. Capitol (TA-W 1301), 3½ ips, mono. 38s.

Although Frank Sinatra gave a winning performance in the film version of Cole Porter's musical, when heard and not seen—as on this record—the flaws begin to show.

His phrasing and interpretation remain superb, but some of the magic in his voice has gone. *C'est Magnifique* is certainly not Sinatra at his best, neither is *I Love Paris*. Honour is done with *It's All Right With Me*.

The seemingly indestructible Maurice Chevalier really shines. The sheer magic of his performance comes over in *Live And Let Live* and *Just One Of Those Things*.

The gamine charm of Shirley MacLaine is part lost on record, although the recognizable “kookie” quality is still there.

**CHRIS BARBER BAND BOX (No. 1).** Columbia (TA-33SX 1158), 3½ ips, mono. 35s.

The Barber band has been in the forefront of trad jazz in Britain since 1955 and this record, first issued four years ago, is a very good example of what it can do both with the standard repertoire and more up-to-date material.

Quite delightful is its treatment of *I'm Gonna Wash That Man Right Outa My Hair*—ideally suited to the Barber trad line-up.

Two of the tracks are given over to Otilie Patterson, whose great control and feeling for singing old-time jazz has been such a great asset to the band and so welcome to record buyers.

“COME FLY WITH ME.” Frank Sinatra. Capitol (TA-W 920), 3½ ips, mono. 38s.

One of Frank Sinatra's finest albums is now available on tape. Most of the numbers are extremely well known—*Around The World*, *April In Paris*, *Brazil* among them.

But part of the record's greatest success was the original material written for it. Particularly effective are the two Sammy Cahn-Jimmy Van Heusen songs *Come Fly With Me* itself and *It's Nice To Go Trav'ling*. Just as pleasant is *Let's Get Away From It All*, an unknown when the disc version was issued in 1958.

The record cannot be issued in Britain as it was recorded in America. One of the most effective tracks was an outstanding version of *The Road To Mandalay*, but the British controllers of the copyright objected to Sinatra's updating of the lyric and general treatment and refused permission for it to be issued here. Instead *It Happened In Monterey* was substituted.

This track has an accompaniment directed by Nelson Riddle. Though no defect in itself, it does not match the mood set for the rest of the album by Billy May.

“Come Fly With Me” is one of the great albums of the 'fifties. It features Sinatra at his swinging best. He is unlikely ever to equal his performance and, therefore, the record is a must for any collector.

## NEW POPULAR MUSIC ON TAPE

**"GET HI!"** With a Group led by Pat Dodd and the Michael Sammes Singers. H.M.V. (TA-CLP 1401), 3½ ips, mono. 35s.

A "knees-up" party record produced for HMV by Fiona Bentley's firm, it consists of medleys of just about every party song you could think of and encourages a community type singing.

The usual quality of EMI tape releases was missing from my copy.

\* \* \*

**GREAT SHOW TUNES.** The Melachrino Orchestra. H.M.V. (TA-CLP 1229), 3½ ips, mono. 35s.

On this record, issued in disc form five years ago, George Melachrino conducts a large orchestra in lengthy medleys from six shows—"South Pacific," "Kiss Me Kate," "My Fair Lady," "Call Me Madam," "Summer Song" and "Show Boat."

The arrangements are very theatrical and, for me, dreary, although there is the solid musical quality about them which has earned Melachrino his reputation.

\* \* \*

**"ELLINGTON IN CONCERT" (VOLUME 2).** Duke Ellington and his Orchestra, World Record Club (TT 195), 3½ ips, mono. 29s.

There is so little Duke Ellington music on the tape record market, that this must be welcomed although there are much better recordings in existence.

The record was made at a public concert in December 1948, before the time of long-playing records, and a good deal has been accomplished since then in the technique of stage recordings.

Nevertheless, there are benefits, notably Ellington's own humorous introductions, particularly of his own composition *The Tattooed Bride*, which ends the record.

There is an exciting performance of *Tootin' Through The Roof* and a beautiful, slow descriptive piece, wonderfully titled *Lady Of The Lavender Mist*.

A big feature of Ellington concerts is the medley of his compositions. This one was no exception and the long piece included *Mood Indigo*, *Sophisticated Lady*, *Beginning To See The Light* and four more. But it is a messy arrangement and not Ellington at his best.

\* \* \*

**OKLAHOMA!** Soundtrack. Capitol (TA-W 595), 3½ ips, mono. 38s.

It is hard to praise this record enough. The show itself broke new ground in the theatre, established the Rodgers and Hammerstein partnership, was an enormous success and was subsequently transferred into an even more successful motion picture.

The film had the advantage of its leading players, particularly Gordon MacRae and Shirley Jones, having fine singing voices and the extra conviction that follows.

The drama of the story, of course, scarcely affects the record, but its nostalgic atmosphere remind, for in-

### By DON WEDGE

of "New Musical Express"



stance, of the terrible moment when Rod Steiger as Judd gets killed.

There are eleven songs, each magnificent, often witty, and all pleasurable.

Highlights are probably Gordon MacRae's *Oh, What A Beautiful Morning*, Shirley Jones' *Out Of My Dreams* and *Many A New Day*, with them topped only by their duet *People Will Say We're In Love*.

Whatever a collector's musical tastes, it is hard to see how this show, and most particularly this record, could be omitted.

\* \* \*

**"OUR MAGIC MOMENTS."** The Randy Van Horne Singers. World Record Club (TT 186), 3½ ips, mono. 29s.

A good value record this. Suitable for pleasant low-key listening, it is a change for background music from the eternal strings. It consists of the Van Horne Singers with instrumental accompaniment at a minimum.

The songs are good, pleasant ones—*Moonlight In Vermont*, *Ebb Tide*, *The Last Time I Saw Paris*, etc.—sung by a choir in which female voices dominate.

The emphasis is on a relaxed approach—a kind of American "Sing Something Simple"—and is only marred by some phoney dramatics on *Two Sleepy People*.

The record was originally made by Everest in America, a firm whose product World Record Club will issue here. It should lead to a more varied release and end the top-heavy WRC catalogue of recreated show albums.

\* \* \*

**THE SEVEN AGES OF ACKER.** Mr. Acker Bilk and his Paramount Jazz Band. Columbia (TA-33SX 1205), 3½ ips, mono. 35s.

Acker Bilk is now one of the four most important individual artists in the current British musical scene. This has come about by the success of his pretty clarinet solos backed by lush strings. This record is of his roots—colourful leader of an excellent traditional jazz band.

Bilk plays in two fields. The one in this record is exclusively that of the popular jazz man.

It includes two of his vocals—I'm *Going Home*, which he wrote, and—unusual to find in a band repertoire—*Run Come See Jerusalem*. Drummer Ron McKay also sings—*Let The Light From The Lighthouse Shine*.

But the vocals do not dominate. There is an excellent treatment of Ketelbey's *In A Persian Market* and of standard jazz repertoire such as Nick La Rocca's *Tiger Rag* and *Ory's Creole Trombone*. There is also one of Bilk's pop hits *Summer Set*.

Though often without adequate feeling, the record is otherwise extremely well played and worthwhile in its idiom.

YOUR LOCAL DEALER

**LONDON**

## HI-FI CENTRE

Branch of KINGS ELECTRONICS

178, HIGH STREET, E.17

Walthamstow's Leading Stockist of all makes of

**TAPE RECORDERS AMPLIFIERS, TUNERS, etc.**

Free Demonstration in the comfort of your own home

PHONE AMH 6242 or COP 4488

## Lee Electronics

THE TAPE RECORDER & HI-FI AUDIO SPECIALISTS

400, EDGWARE ROAD, LONDON, W.2

London's leading Stockists of High-Fidelity and Audio Equipment.

Many Bargains in new and reconditioned Equipment

SEND FOR FREE LISTS OF RECORDING TAPES, RECORDERS, AMPLIFIERS, ETC

All Machines demonstrated for performance on Record and Playback. All leading makes of Hi-Fi equipment from stock

PADDINGTON 5521

- ★ TAPE RECORDER HIRE
- ★ TAPE TO DISC 78 & LP
- ★ RECORDING STUDIO
- ★ TAPE RECORDER REPAIRS
- ★ SALES—EXCHANGES

## MAGNEGRAPH

1, Hanway Place, London, W.1.

Tel.: LANGham 2156

Leonard G. Francis presents—

### SHEEN

TAPE RECORDER CENTRE LTD.

Specialists in Tape Recorders and Accessories etc.

—THE CENTRE FOR—

FRIENDLY HELP — SALES — SERVICE

HOME DEMONSTRATIONS ANYTIME

—MODELS FROM 19 GNS.—

PRE-RECORDED TAPE: LANGUAGES

DANCE CLASSICS JAZZ

CALL—WRITE—PHONE

8 Station Parade, Sheen Lane, Sheen,

London S.W.14 (next to Mortlake Station, S.R.)

Showrooms: PROSPECT 0985 10 a.m.—7 p.m.

**YOUR LOCAL DEALER**

## THE SOUTH

**PORTSMOUTH and  
SOUTHAMPTON**

**Tape Recorder Specialists**

APPROVED AGENTS FOR:—  
PHILIPS · GRUNDIG · FERROGRAPH  
VORTEXION, ETC.

- ALL MAKES OF TAPE RECORDERS SUPPLIED
- ACCESSORIES AND HI-FI EQUIPMENT
- PART EXCHANGES AND SECOND-HAND MACHINES
- PROMPT AND SKILLED SERVICING

**RECORDING MACHINES LTD.**

299 Commercial Road, Portsmouth  
Telephone: 23097  
4 New Road, Southampton  
Telephone: 27092



## TAPE RECORDERS

(Bournemouth) LTD (Exeter)

Southern England's  
Biggest Centres for  
PHILIPS · FERROGRAPH  
GRUNDIG · TELEFUNKEN  
BRENELL · AND ALL LEADING MAKES

Accessories by return Call, write or phone

**THE TAPE RECORDER PEOPLE**

874 Christchurch Rd., BOURNEMOUTH Tel. 45096  
3 Seamoor Road, WESTBOURNE Tel. 64292  
1 Sidwell Street, EXETER Tel. 75779

*For all your Tape Recorder  
and Cine requirements*

## UNIVERSITY CAMERAS

of

**SOUTHAMPTON**  
12 BARGATE STREET

Telephone: 28547

## SCOTLAND

### GLASGOW

**Tape Recorder Specialists**

APPROVED AGENTS FOR:—  
PHILIPS · GRUNDIG · FERROGRAPH  
VORTEXION, ETC.

- ALL MAKES OF TAPE RECORDERS SUPPLIED
- ACCESSORIES AND HI-FI EQUIPMENT
- PART EXCHANGES AND SECOND-HAND MACHINES
- PROMPT AND SKILLED SERVICING

**RECORDING MACHINES LTD.**

60 ST. VINCENT STREET, GLASGOW, C.2  
Telephone: City 3847/8

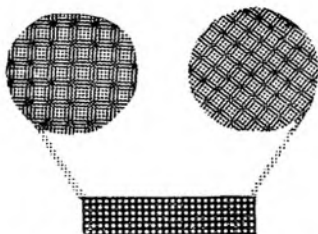

## NEW PRODUCTS

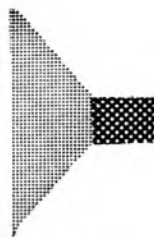

## New Telefunken model

**L**AATEST model to come from the Telefunken stable is the Magnetophon 98, a three-speed stereo tape recorder.

This half-track machine, with speeds of  $7\frac{1}{2}$ ,  $3\frac{3}{4}$  and  $1\frac{7}{8}$ , will accommodate seven-inch spools, and provides a playing time of eight hours' mono or four hours' stereo using double-play tape.

The frequency range is quoted as 30-18,000 cps at  $7\frac{1}{2}$  ips, the top figure reducing to 16,000 cps and 9,000 cps at  $3\frac{3}{4}$  and  $1\frac{7}{8}$  ips respectively. Signal-to-noise ratio is given as better than 55dB, 50dB, and 45dB at these speeds, and wow and flutter is rated at within 0.15, 0.2, and 0.3 per cent respectively.

Among the facilities are automatic tape and stop control; stereo balance control; automatic braking and tape tension system; tone control; separate controls for recording and playback; three digit rev. counter; neon recording level indicator; pause control; and facilities for echo and reverberation effects.

Inputs are provided for a stereo microphone (2mV in 2 M ohms); and for radio (2mV into 47 K ohms). Playback outputs are incorporated for radio (1v into 18 K ohms) and loudspeaker (2½ watt loaded with 4.5 ohms). Facilities are also available for mono and stereo earphone or loudspeaker monitoring comparing the ingoing signal with the signal from



**The Telefunken 98**

the tape. A tape-splicing groove is fitted above the tape channel.

Other features include intertrack transcription and straight-through-amplification. The loudspeaker is a built-in 10 x 3-inch elliptical unit with a cut-out switch.

The valve line-up includes two EF86, two ECC82, two EL95, and an EM84.

The Magnetophon 98 measures 16 x  $11\frac{1}{2}$  x  $7\frac{1}{2}$  inches and weighs 29 lb. It sells at 95 guineas, including 5½-inch long-play tape and an empty spool.

Welmecc Corporation Limited, 147, Strand, London W.C.2.

## LEE ELECTRONICS ANNOUNCE MIXER UNIT

**A** FOUR-CHANNEL transistorised mixer unit has been introduced by Lee Electronics. The new unit is designed to feed four high impedance sources into a single high impedance input of a tape recorder or amplifier.

The maximum input signal acceptable is 1½ volts, and this can be raised to a

case, measuring 6 x  $3\frac{1}{2}$  x 3 inches, the mixer will retail at £3 19s. 6d. It is supplied complete with full instructions, battery and circuit diagram.

Low impedance microphones can be used with this unit, in conjunction with a microphone matching line transformer, or a transformer booster unit such as the Grundig MA1.

Lee Electronics, 400, Edgware Road, London, W.2.



**Lee Electronic's four-channel mixer**

maximum output of 2½ volts. The output for minimum distortion is estimated at two volts, the hum level is rated at zero, and gain is given as approx. 6dB.

The battery complement, nine volts at four milliamps, is estimated at 400 hours, with approx. six months normal use.

Fitted in a gold-finish shelf-mounting

## MORE AGFA TRIPLE-PLAY

**A**GFA Limited announce additions to their range of triple-play tape. Added to the three- and five-inch reel lengths, announced and illustrated in our July, 1962 issue, are three further lengths on 4½, 5½ and 7-inch reels.

Their entire range of PE65 Polyester-based triple-play tape now reads as follows (tape lengths given in parentheses):

Three-inch (450 ft.), 22s. 6d.; four-inch (900 ft.), 39s.; 4½-inch (1,200 ft.), 46s. 3d.; five-inch (1,800 ft.), 66s. 3d.; 5½-inch (2,400 ft.), 88s.; and seven-inch (3,600 ft.), 133s. 9d.

Agfa Limited, 27, Regent Street, London, S.W.1.



# GRUNDIG "MAGIC EAR" RECORDER

A FULLY automatic tape recorder has been announced by Grundig, who have introduced their TK18. This is a single speed (3½ ips), two-track recorder which will accommodate up to 5½-inch spools.

The playing time available is one hour per track using long-play tape (1,200 ft.), with rewind being accomplished within 2½ minutes.

The outstanding feature of the TK18 is the "Magic ear" which retains the correct recording level so that the full dynamic range of music or speech is faithfully reproduced. It has a quoted

frequency response of 40-12,000 cps+3-5dB; the signal-to-noise ratio is given as better than 50dB; and wow and flutter as less than 0.2 per cent.

Inputs are supplied for microphone (2mV into 5 M ohms), and radio/pick-up (80mV into 1 M ohm). Outputs are for high impedance (500mV at 15 K ohms), and low impedance (5 ohms). The power output is rated at 2½ watts through a 5½ x 4½ inch elliptical loudspeaker.

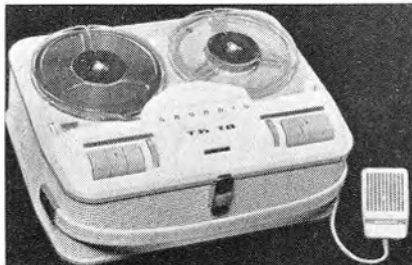

The Grundig TK18

Mains voltage is 200-220, 220-240 v, AC, 50 cycles. Consumption is rated at 55 watts maximum. The valve line-up includes an ECC83, ECL86, and EM84, plus two metal rectifiers.

Measuring 14½ x 11½ x 6½ inches, the TK18 weighs 20 lb. Included in the price of 39 guineas is a moving coil microphone (Type GDM18).

Also recently announced by Grundig is their Stereo Mixer Unit Type 608, which replaces their earlier models. This 18-guinea unit, also suitable for mono use, is fully transistorised and is fed from two PP3 batteries (or equivalent).

It is fitted with connecting sockets for two microphones, a further mono channel, the connection of a radio receiver and a stereo gram. pick-up. A mono/stereo output socket is also provided.

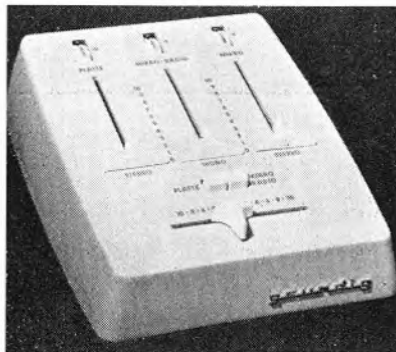

Grundig's Type 608 Mixer

Studio type linear fading controls are fitted. Inputs from a mono microphone or radio can be mixed with a stereo programme, and, with the aid of a "Directional Control" these mono inputs may be mixed with either channel or combined with both. Coarse level controls are provided to prevent over-modulation.

The frequency response is said to be substantially flat between 30 and 20,000 cps. The Mixer 608 measures 9½ x 8 x 3 inches and weighs 3½ lb.

Grundig (Great Britain) Limited, Newlands Park, Sydenham, London, S.E.26.

## YOUR LOCAL DEALER

### MIDLANDS

#### Audio Electronics (Midlands) Ltd.

Specialists in Dictation Mcs., Tape Recorders, Inter-Com., Tapes and Accessories

Full After Sales Service on all Equipment  
PHILIPS, GRUNDIG, TRUVOX,  
ELIZABETHAN, ETC.

203 STAFFORD STREET,  
WALSALL. Tel.: 21086

#### SOUND BUSINESS

Specialists in  
Sound Reproducing Equipment  
Stockists of Butoba, Grundig,  
Sony, Tandberg, Vortexion, etc.

Backed by a  
First-Class Service Department

#### TYSONIC

W. M. Tyson, M.Brit.I.R.E.  
41 Russell St. Leamington Spa  
phone 24935

#### TAPE RECORDER CENTRE (Halifax)

stock all the best tape recorders and hi-fi equipment. Agents for Revox, Tandberg, Ferrograph, etc. Demonstrations by expert staff. Two years' free service on recorders over £35.

30 King Cross St., Halifax. Phone 66832

#### Tape-to-Disc Services

##### RAPID

#### Recording Service

78s and L.P.s. from your own tapes. (48 hour service). Master Discs and pressings. Recording Studio. Mobile Recording Van.

Associated Company—  
**EDUCATIONAL RECORDINGS LTD.**

Specialists in Sleep-learning and Audio Learning. Tapes on Mind Management; Positive Personality; Memory Training; How to Pass Examinations. Manufacturers of the "Sleep-o-matic Unit" to be used with our Sleep-learning tape. Foreign language courses available for sleep-learning.

Brochures on request from:—  
RAPID RECORDING SERVICE (Dept. TRG)  
21 Bishops Close, Walthamstow E.17 COP 3889

## New battery recorder

LATEST battery operated tape recorder to be introduced to the market is the Japanese manufactured Belsona TRQ-399 announced by Lee Products.

This is a two-speed recorder, 3½ and 1½ ips, which will accommodate three-inch spools. The playing time available is fifty minutes per track using the new triple-play tape (450 ft.) at the slower speed.

The quoted frequency response is 150-7,000 cps at 3½ ips, and 150-4,000 cps at 1½ ips. The power output is rated at 500 mW through the 4 x 2½-inch built-in loudspeaker. Power is obtained from four 6-volt torch batteries (used for both amplifier and motor). The amplifier

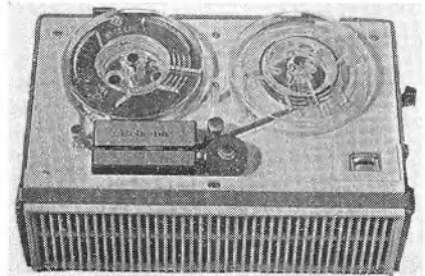

The Belsona TRQ-399

uses six transistors, and one transistor high-frequency generator.

One unique feature of the Belsona is a constantly variable rewind speed, the only such device to be found on current battery portables. Rewind is estimated at less than four minutes. As with many current models, the controls are designed so that they can be easily operated while the protective cover is closed. Other features include a combined record level and battery life indicator; printed circuit wiring; facilities for earphone monitoring; and an extension speaker socket.

A dynamic microphone is included in the price of 35 guineas. Also included are a number of accessories. These are monitoring earphone, recording leads, splicing tape, polishing cloth, leather carrying case and strap, a spool of tape and an empty spool. The Hitachi AC Adaptor, sold separately, is also available to enable a supply to be tapped from a mains source.

It measures 8½ x 6½ x 3½ inches, and weighs 4½ lb.

Lee Products (Great Britain) Limited, 10-18, Clifton Street, London, E.C.2.



## ONLY A PILLAR-BOX AWAY!

Wherever you live, you are only a 3d. stamp away from the biggest Specialists in the Country! We *guarantee* our terms—which include **NO INTEREST CHARGES**—cannot be beaten.

*Thinking of buying a Tape Recorder? Interested in saving money?* Then write or phone us today for Free Brochures on all the best makes and Full Details of our Amazing Offers:

# HOWARD

218 HIGH STREET,  
BROMLEY, KENT

RAVensbourne 4000/4477



# News from the Clubs

## ABERYSTWYTH

A change of secretary is announced for the club in Aberystwyth. The post vacated by Mr. Gareth Jenkins has now been filled by Mr. Islwyn Nicholas, Glasgoed, Elmtree Avenue, Aberystwyth, West Wales.

## Ayr

A new tape club has been formed in Ayr. The first meeting, held in January, revolved round a demonstration of tape recorders given by Mr. A. F. Hood of Fairbairns Ltd., a local dealer. Included in the demonstration were a number of the latest transistorised and battery-operated machines.

The second meeting, held on February 13 in the Ayrshire and Galloway Hotel, Burns Statue Square, saw the presentation of a film-show with taped sound-tracks.

Secretary: S. J. Hourston, 79 Whitlets Road, Ayr, Ayrshire.

## BIRMINGHAM (SOUTH)

Activities in the South Birmingham club have become very hectic over the past few weeks. The usual fortnightly meetings have been supplemented by a visit to the Kidderminster society, and the supplying of sound effects to a local dramatic society who were presenting Mary Hayley Bell's *Duet for Two Hands*.

Over forty cues were required for the play which is set in the Orkney Islands. Gulls and rolling surf were the main effects required, and these were eventually recorded on one tape and faded in and out on one recorder when needed.

A second recorder supplied such sounds as a horse and cart arriving and departing, a dog barking, and a thunderstorm. Even when the script called for a non-piano-playing character to perform on the ivories the members were unabashed and provided a beautifully synchronised recording. Three or more members attended rehearsals twice a week, and the play was presented for five performances.

Their success has since led to further requests from other societies.

I can understand their jubilation, for I was recently called upon to provide effects for a pantomime. A ship at sea provided the main problem; they required howling winds and creaking timbers throughout two scenes (quite easy with the sounds on separate tracks on a looped tape played on a stereo recorder) and also various effects, a collision, a ship being torn into two parts, thunder, and rat(!) noises. Like the Birmingham members I used two recorders, but unlike them I had no assistants, and also played one of the pantomime characters. From now on I am pure audience!

Later news from these clubs is that they are now meeting on the first and third Mondays in the month, with an additional meeting on the fifth Monday. More recent meetings have included demonstrations of the Sony and Revox stereo recorders, and the secretary and chairman have been impressed enough to purchase the two machines.

The club film *Parade* was shown at the Christmas party attended by forty members and friends. Further shots were taken, and these will be added to the film to complete the year's activities. A sound track is being prepared and the completed film is due for its "premiere" in March.

Secretary: J. T. Gilbert, "Woodcote," Box Trees Road, Dorridge, Solihull, Warwickshire.

## BOSTON

The most ambitious event of the Boston Soundhunters took place in December when members arranged a concert by television singing guitarists Joy and Jennifer. Presented in aid of the Blackfriars Trust project to convert an old Dominican Friary into a theatre, the concert is described as having been most successful. An impressive array of stereo and mono equipment, including recorders by Sony, Tandberg, Vortexion, Uher, Brenell, and Philips was assembled.

Encouraged by their success the members then planned a demonstration of high fidelity sound reproduction by tape for February 11.

Earlier trick recording and sound effects had been the order of one meeting. Members were called upon to provide a tape including four sounds: a telephone ringing; a simulated recording of a river tug-boat; the most unusual; and the best sound effect. K. Healey was the eventual winner and he was awarded an Emiguide.

## GLASGOW (2)

A second club has been formed in Glasgow. The new club, known as the West of Scotland T.R.C., meets every Monday at 43 Garnethill Street.

One of their earliest activities was to start production on a tape entry for the British Amateur Tape Recording Contest. Secretary A. McCallum wrote that their entry is now well under way, and they are convinced they will win the club section with their first entry.

Among other activities have been a demonstration on building a mixer unit, presented by J. Knowles; an editing session, with members competing for the best result of editing a recorded tape; and a demonstration, by Albert Barnes, of his Philips battery recorder.

A publicity drive has been started, and members have sought the aid of six local dealers who have agreed to display leaflets about the club.

Secretary: A. McCallum, 9 Glendevon Square, Glasgow, E.3.

## INTERNATIONAL VOICES OF YOUTH

A new tape club, founded and operated by the "leaders of tomorrow" has been organised in America. Full details of the club, described as a non-profit, non-political, non-sectarian organisation striving for world peace through tape exchanges, are available from Post Office Box 3041-C, San Mateo, California, USA.

## LONDON

Latest meeting of the London club was attended by members of the Bethnal Green society who had travelled across town for a special "open night." First item on the programme was a tape/slide show presented by the chairman, Ken Blake. His show *The End of the Line* was a last look at a train journey from North London to dockland, a line which is no longer open to passenger traffic. Following this his guest for the evening, David Mowhan, gave a graphic demonstration of good and bad stereo. His programme included a short interview between Ken and David, and ended with a stirring presentation of *Scheherazade*.

After the usual interval and an enormous amount of "cats," members heard the latest effort in the club's second series of *Passing the Buck*. This is a tape to which each member contributes a few minutes recording before stopping his story in mid-stream ready for the next member's efforts.

Then came the unexpected highlight of the evening with Ron Tucker's presentation of a tape made for Dr. Barnardo's Homes. For his programme Ron had eavesdropped on the children visiting Santa Claus in a London Store. Having primed Father Christmas beforehand of the eventual destination of the tape, Ron had then interviewed the Old Gentleman himself.

The meeting closed after Roger Aslin had presented a tape of extracts from tapes made by the

## Lecture/Demonstrations

CLUBS wishing to invite demonstrations (and/or lectures are invited to contact the following companies who have offered their services:—

BASF Chemicals Ltd., 5a Gillespie Road, London, N.5.  
FI-Cord Ltd., 40a, Dover Street, London, W.1.

Grundig (Great Britain) Ltd., Newlands Park, Sydenham, S.E.26.

Lustraphone Ltd., St. George's Works, Regent's Park Road, London, N.W.1.

Truvox Ltd., Neasden Lane, London, N.W.10.

Further names will be added as received.



Television singing guitarists Joy and Jennifer are interviewed by Boston Soundhunter Tony Jewers, before the fund-raising concert organised by the club members. In the background, left to right, are A. Blakeley, A. L. Brumpton, M. Pocklington, with club leader Philip Towell operating the Sony 521 in the foreground.

club during its early days, and including a recording of the inaugural meeting in 1957.

Secretary: Fred Fowle, 66 East Road, London, N.1.

## MIDDLETON

A change of secretary is announced for the Middleton club with J. R. Witts replacing George West, who is now assistant secretary.

They have also changed their meeting rooms, but no information regarding the new venue is available. Since their move, the members have been kept active. Among their activities have been a sound hunt; a talk on echo effects with demonstrations by George West; and a lecture on brass bands with recorded illustrations by Brian Gilbert. They have also combined forces with the Oldham Gramophone Society with whom they saw a showing of the B.A.S.F. film *The Magic Tape*.

Other activities have included a visit to a telephone exchange at Manchester's Dial House; the recording of three carol services, one performed by members of the Boys Life Brigade; and recording an audition for a small group in a public house. Although the acoustics were unmentionable in the latter instance, members managed to get a good recording by dint of much experimenting with microphone positions. The recorder used was a Simon SP5, with a Grundig four-channel mixer and Reslo, Simon Cadenza, Grundig and Grampian microphones.

The members are now planning a tape production dealing with the history of Middleton churches.

Secretary: J. R. Witts, 119 Heywood Old Road, Rhodes, Middleton, Lancashire.

## NORTHAMPTON (tape and cine)

A marked increase in membership is announced by the members of the Northampton club following their removal into new club rooms. Secretary R. Foster is undecided whether the increase is as a result of a change from Tuesday to Thursday meetings, or because they have moved from licensed premises to tea and biscuits. Either way they now boast an average weekly attendance of forty.

Six of these members recently made stereo and mono recordings of the Northampton Light Orchestra, under its conductor Mr. Len Andrews, for the benefit of the local blind.

Their plans for the first National Tape and Cine Rally are forging ahead, and a firm date is now fixed for March 30, between 2 and 9 p.m., at the Central Methodist Hall, Regent Square. A sixteen-page programme of events is being printed, and will be available by February. Clubs wishing to take part are invited to contact the secretary direct.

At one of their recent meetings a 100 ft. test reel of 16mm film concerning the local brewery was shown to members by chairman Mr. C. W. Percy. Members have agreed to co-operate with Mr. Percy to produce a thirty-minute 16mm film about the production of "Red Barrel," and are to complete the sound and commentary by April.

Secretary: R. C. Foster, 17, Shakespeare Road, Northampton.

(Continued on page 31)



Just as any big building needs good foundations to ensure lasting strength and stability, modern magnetic tapes need a firm foundation-backing to ensure lasting high-quality reproduction and great tenuous strength. A backing like the special polyester film, a feature of "SCOTCH" magnetic tapes — sound, video, instrumentation and computer. "SCOTCH" polyester-backed magnetic tapes are the expert's first choice. Leading disc makers use

them for master recordings. More than 90 per cent of the world's taped TV programmes are broadcast from "SCOTCH" Video Tape No: 379 with polyester backing.

But "SCOTCH" polyester-backed magnetic tapes are not strictly for the experts. The experienced enthusiast, who settles for nothing less than the very best in consistent high-quality reproduction, great tear resistance and temperature stability, chooses...

## <sup>Trade Mark</sup> Scotch Magnetic Tape

No. 102 Standard Play. 150 Extra Play. 200 Double Play.

**3M** MINNESOTA MINING & MANUFACTURING COMPANY LIMITED 3M HOUSE, WIGMORE STREET, LONDON, W.1. TEL: HUNTER 5522

## News from the Clubs

(Continued from page 29)

### RECORDED TAPES CLUB (S. Africa)

Members of the Recorded Tapes Club in South Africa recently made a particular request for tape exchange contacts with clubs in this country. Club members interested should write direct to the club, c/o P.O. Box 255, Pinetown, Natal, South Africa.

### RUGBY

A talk on services to the blind through tape recording was given by Coventry club member Rupert Gillard of Nuneaton at the January 17 meeting of the Rugby club. Mr. Gillard is the author of a magazine tape which is circulated by the Cultural Society for the Disabled. His talk covered his entrance into this type of service, the choice of material for the magazine; and how he builds up his programme. He also described the value and difficulties of producing his feature tapes.

At an earlier meeting members heard a tape from the Bloemfontein Camera Club. The South African members had compiled a programme illustrating the work of four of their members. Included in the tape were comments from a food manufacturer's agent, a warehouseman, a radio technician, and a Methodist minister. This was followed by an introduction to the geography of South Africa.

The members then set about making a reply tape. Later in the meeting Secretary Mike Brown presented his quiz tape. This was won by Assistant Secretary Bob Pick who received a three-inch spool of tape.

The meeting closed with an informal talk on battery portable recorders.

Very Tilcock has been assisting the Matron and Sister Tutor of a hospital in preparation for their contribution to an Exhibition of Careers held in Rugby. The assistance included the production of a taped commentary for a slide show about nursing. The demonstration took its place alongside similar tapes on farming, building, civil service, the Forces, etc., and was very well received.

Secretary: Michael Brown, 219 Clifton Road, Rugby, Warwickshire.

### WALSALL

A change of secretary and chairman was announced at the AGM of the Walsall club. The post formerly held by founder-secretary Mrs. Joan Walford has now been filled by Paul Clark, and Peter Lane has replaced Douglas Robins as chairman.

One of the recent activities of members nearly ended up with an assault being made on member Paddy Finnegan. The club had decided to conduct a number of initiative-tests interviews around the town equipped with battery portables. Mr. Finnegan was required to ask any one of the town's

many coloured visitors for his opinion of British policemen. Co-operation was obtained regarding the preliminary questions of name, address and country of origin, but the trouble started with the pertinent question. At a hilarious playback it was obvious from the man's unveiled hostility and mounting excitement that the interviewer came within a shade of being assaulted and had considerable difficulty allaying the suspicions of the subject and three fellow countrymen who joined the scene.

Elsewhere in the town other members made successful interviews with bus crews, a bus passenger, and a police desk sergeant.

The members have prepared a short commercial tape for free distribution by a local retailer. Copies of the tape are being prepared by Mr. M. L. Chambers for presentation by him to purchasers of new machines.

Secretary: Paul Clark, 20, Springvale Avenue, Parkhall, Walsall, Staffordshire.

### WORLD WIDE TAPE TALK

A booklet, entitled *Etiquette for Tapetalkers*, has been produced by World Wide Tape Talk, the international tape exchange organisation. The booklet, obtainable from A. R. Hunt, at "Winton," Palmers Road, Wootton Bridge, Ryde, Isle of Wight, list a number of "do's" and "don'ts" with regard to tape talking. It costs 6d. p. & p.

## CLUB MEETING DIARY

**ABERDARE:** Alternate Wednesdays at Cwmaman Institute, Cwmaman. (Feb. 20.)

**ABERDEEN:** 1st Tuesday in every month at 8, Deer Road, Woodside.

**ABERYSTWYTH:** Details from Islwyn Nicholas, Glasgoed, Elmtree Avenue, Aberystwyth.

**AYLESBURY:** Monthly at Hazell's Club, Britannia Street, Aylesbury 3088.

**AYR:** Details from S. J. Hourston, 79, Whitlatts Road, Ayr.

**BARNSELEY:** Every Tuesday at YMCA, Eldon Street.

**BATH:** Every Wednesday at 24, Green Park.

**BATH (2):** Alternate Wednesdays at 41, Herbert Road, Oldfield Park. (Feb. 20.)

**BEDFORD:** Final Tuesday in month at 131, London Road.

**BELFAST:** Every Thursday at 44, Dublin Road, Belfast 2.

**BIRMINGHAM:** Every Monday at the Chapel Tavern, Ludgate Hill.

**BIRMINGHAM (SOUTH):** 1st, 3rd and 5th Mondays at Bredon Cross Hotel, Pershore Road.

**BLACKBURN:** 1st and 3rd Tuesdays at Blackburn YMCA.

**BLACKPOOL:** Alternate Wednesdays at the Albert Hotel, Lytham Road. (Feb. 27.)

**BOSTON:** 2nd and 4th Tuesdays at Pilgrim College, South Square.

**BOURNEMOUTH:** Alternate Tuesdays at the Pembroke Hotel, Poole Hill. (March 5.)

**BRIDGWATER:** Every Tuesday at Evis' Radio Shop, West Street.

**BRIGHTON:** Every Wednesday at the Downside School, Ditchling Road.

**BRISTOL:** Alternate Thursdays at 4, Kings Square, Bristol 2.

**BROMLEY:** 2nd and 4th Thursdays at St. Mary's Church Hall, College Road.

**CAMBRIDGE:** Every Wednesday at the Mire Hotel, Bridge Street.

**CARDIFF:** 1st and 3rd Tuesdays at 46, Caroline Street.

**CHESTERFIELD:** Every 3rd Monday at the Yellow Lion Inn, Saltergate. (March 4.)

**CLACTON:** Every Monday at Ebor Lodge Hotel.

**COTSWOLD:** Fortnightly, alternating Monday and Thursday at Bayhill Hall, Royal Well Lane, Cheltenham. (Feb. 21.)

**COVENTRY:** Alternate Wednesdays at the Holyhead Hotel, Holyhead Road. (Feb. 27.)

**COVENTRY** (audio and cine): Alternate Tuesdays at the Liberal Club, Union Street. (Feb. 26.)

**CRAWLEY:** 1st and 3rd Mondays at Southgate Community Hut.

**DARTFORD:** Every Thursday at 41, Winsor Drive.

**DERBY:** Alternate Wednesdays at Osmaston Park Hotel. (Feb. 27.)

**DONCASTER:** Alternate Thursdays at Lancaster House, Westlaine Gate. (Feb. 28.)

**DOVER:** Alternate Mondays at the Priory Hotel, Dover. (March 4.)

**DUBLIN:** 1st Monday at "Hardy House," 6, Capel Street.

**DUNDEE:** Alternate Mondays at The Salvation Army Hostel, 31, Ward Road. (March 4.)

**EASTBOURNE:** Alternate Saturdays at Hartington Hall, Bolton Road. (March 2.)

**EAST HERTS:** Alternate Mondays at 3, Chadwell Ware. (March 4.)

**EDINBURGH:** 1st and 3rd Wednesdays at 82, Newbattle Terrace, Edinburgh 10.

**ERITH:** Every Wednesday at South Reach County Boys' Club, Manor Road, Erith.

**GLASGOW:** Alternate Mondays at 91, North Hanover Street, Glasgow, C.2. (Feb. 25.)

**GLASGOW (2):** Every Monday at 43, Garnethill Street.

**GRIMSBY:** First Monday at 21, Langton Drive, Nunthorpe, Grimsby.

**HARROGATE:** Every Wednesday at 4, Belford Road.

**HASTINGS:** Every Thursday at The Rising Sun, East Parade.

**HINCKLEY:** Alternate Wednesdays at The Wharf Inn, Coventry Road. (Feb. 20.)

**HOVE:** Every Thursday at 44, Hogarth Road, Hove.

**HUDDERSFIELD:** 1st and 3rd Wednesday and last Monday at the Public Library, Ramsden Street.

**HULL:** Every Tuesday at 592, Hessle Road.

**ILFORD:** Alternate Fridays at the Gants Hill Library, Cranbrook Road. (March 8.)

**IPSWICH:** Alternate Thursdays at the "Cock and Pye" Inn, Upper Brook Street. (Feb. 28.)

**JARROW:** Alternate Mondays at Jarrow Central School. (March 4.)

**JERSEY:** 1st and 3rd Mondays at "Santa Barbara" Maufant, St. Saviour.

**KEIGHLEY:** Alternate Wednesdays at the Spencer Street School Rooms. (Feb. 20.)

**KETERING:** 2nd and 4th Wednesdays at the Rising Sun, Silver Street.

**KIDDERMINSTER:** Alternate Wednesdays at the NFU Meeting Room. (Feb. 27.)

**LEEDS:** Alternate Fridays at the YMCA, Albion Place, Leeds 1. (March 1.)

**LEICESTER:** Alternate Thursdays at the Leicester Museum. (Feb. 21.)

**LUTON:** 2nd and 4th Tuesdays at Flowers Recreation Club, Park West, Luton.

**MAIDSTONE:** Every Wednesday at the Ex-Service Club, Ashford Road.

**MANCHESTER:** Every Saturday, 6 p.m., at 20, Naylor Street, Hulme, Manchester 15.

**MEDWAY:** Every Monday at 23, Edward's Close, Wigmore, Gillingham.

**MIDDLESBROUGH:** Every Friday at 130, Newport Road.

**MIDDLETON:** Details from J. R. Witts, 119, Heywood Old Road, Rhodes.

**MILLOM:** Every Wednesday at Millom Centre.

**NORTHAMPTON:** Every Tuesday at Studio One, Cross Keys Hotel, Sheep Street.

**NOTTINGHAM:** Alternate Thursdays at the Co-operative Educational Centre, Heathcote Street. (Feb. 21.)

**NORWICH:** 4th Tuesday at "Lady Chamberlin Hall," 38a, St. Giles Street.

**PETERBOROUGH:** Alternate Thursdays at The Youth Centre.

**PONTYPOOL:** Every Monday at the Hospitality Inn, Crumlin Road.

**PLYMOUTH:** Every Wednesday at Virginia House, Palace Street, Plymouth.

**READING:** Every Monday at Abbey Gateway.

**REDDITCH:** 4th Thursday at The White Hart Hotel, Headless Cross.

**RHYE:** Alternate Tuesdays at Studio A, Bedford Street. (Feb. 26.)

**ROTHERHAM:** Alternate Thursdays at St. John's Church Hall, Masbro'. (Feb. 21.)

**RUGBY:** Alternate Thursdays at the Red Lion, Sheep Street. (Feb. 28.)

**SHEERNESS:** Alternate Fridays at Arthur Gisby's, 136, High Street. (March 1.)

**SOUTHALL:** Every Monday at Southall Community Centre.

**SOUTHAMPTON:** Alternate Mondays at Prospect House, 8, Manchester Street. (Feb. 25.)

**SOUTH DEVON:** Alternate Wednesdays at the YMCA, Castle Circus, Torquay. (Feb. 27.)

**STAFFORD:** Alternate Tuesdays at The Grapes Bridge Street. (March 5.)

**STEVENAGE:** 1st and 3rd Tuesdays at the Tenants' Meeting Room, Marymead.

**STOCKPORT:** 1st and 3rd Fridays at Stockport Boys' Club, Hempsshaw Lane.

**SWANSEA:** Every Thursday at the YMCA Buildings, St. Helen's Road.

**TAUNTON:** 2nd and 4th Wednesdays at the Priory Senior School, Cranmer Road.

**THORNTON HEATH:** Every Thursday at The Wilton Arms, High Street, Thornton Heath.

**TRURO:** Last Wednesday at the London Inn, Pydar Street.

**URMSTON:** Contact Keith Alker, 26, Hayewater Road.

**WALSALL:** Every Wednesday at the New Inn, John Street.

**WARWICK & LEAMINGTON:** 1st and 3rd Wednesdays in Room 18 of the Royal Leamington Spa Town Hall.

**WEST HERTS:** Fortnightly, alternating at the Cookery Nook, High Street, Watford. (March 6.)

Heath Park Hotel, Hemel Hempstead. (Feb. 20.)

**WEST MIDDLESEX:** 2nd and 4th Thursdays at Dormers Wells Primary School, Dormers Wells Lane, Southall.

**WEST WALES:** 1st and 3rd Fridays at The Meeting House, New Street, Aberystwyth.

**WEYMOUTH:** Alternate Wednesdays at The Waverley Hotel, Abbotsbury Road. (Feb. 20.)

**WHITSTABLE:** Alternate Mondays at The Record Centre, Oxford Street. (Feb. 25.)

**WINDSOR:** Every Thursday at 57, St. Leonard's Road.

**YEOVIL:** Alternate Thursdays at the Mermaid Hotel, Princess Street. (Feb. 21.)

**YORK:** Every Thursday at 62, Micklegate.

### LONDON

**ACTON:** Every Monday at the "Albion," Churchfield Road, Acton, W.3.

**BETHNAL GREEN:** Every Wednesday at Bethnal Green Town Hall, Cambridge Heath Road, E.2.

**BRIXTON:** Every Tuesday at The White Horse, 94, Brixton Hill, S.W.2.

**CATFORD:** Every Thursday at the Black Horse, Rushey Green, Catford, S.E.6.

**FRIERN BARNET:** 2nd Friday at 7, Hams-worth Way, N.20; and 4th Thursday at 146, Friern Barnet Lane.

**LEYTONSTONE:** Alternate Wednesdays at Harrow Green Library, London, E.11. (Feb. 20.)

**LONDON:** 2nd Thursday at the Marquis of Granby, Chandos Place, Charing Cross, W.C.2.

**NORTH LONDON:** Every Wednesday at Bush Hill Park School, Main Avenue, Enfield, Middx.

**SOUTH-WEST LONDON:** Every Wednesday at Mayfield School, West Hill, S.W.15.

**STOKE NEWINGTON:** Every Wednesday at 53, Londesborough Road, N.16.

**TUFNELL PARK:** Details of meetings from G. Wilgrove, 38, Highgate Road, N.W.5.

**WALTHAMSTOW:** Alternate Fridays at 22, Orford Road, E.17. (March 1.)

**WOOLWICH:** Alternate Mondays at the North Kent Tavern, Spray Street, Woolwich. (Feb. 25.)

Unless otherwise stated, meetings start between 7 and 8 p.m.

# CLASSIFIED ADVERTISEMENTS

Rate—Sixpence per word (minimum 5s.); Trade, ninepence per word (minimum 10s.); box numbers, one shilling extra. Payment with copy. Copy should be sent to Advertising Department, "Tape Recording Magazine," 7, Tudor Street, London, E.C.4.

## SITUATIONS VACANT

### MIDDLESEX COUNTY COUNCIL— EDUCATION DEPT.

LABORATORY STEWARD for Language Laboratory, Ealing Technical College, St. Mary's Road, Ealing, W.5. Should be suitably qualified by training and/or exper. in electrical maintenance and have interest in tape recordings, projection equipment, and organisation of tape library. Salary within Misc. IV £645—£710, plus London Weighting up to £40. Prescribed conditions. Written application with full particulars to Principal, above address, immediately (Quote M.377 TRM).

## FOR SALE

Wearite 4/A deck (Ferrograph) in good condition £30. Foote Cray 8502, after 5 p.m.

## ORDER TO NEWSAGENT

FOR

### "TAPE RECORDING MAGAZINE"

Published on the third Wednesday  
In every month. Price 1s. 6d.

To .....

(Newsagent's name and address)

Please deliver me one copy of  
"TAPE Recording Magazine"  
each month until further notice.

(Signed) .....

Address .....

TAPE Recording Magazine is published by  
Print & Press Services Ltd., 7, Tudor Street,  
London, E.C.4, and distributed by Trans-World  
Circulation Co., Park Royal Road, N.W.10.

## ORDER FOR ANNUAL SUBSCRIPTION TO "TAPE RECORDING MAGAZINE"

Please post me one copy of  
"TAPE Recording Magazine"  
monthly for one year. I enclose  
£1 in payment to commence  
.....issue.

(Signed) .....

Address .....

## MISCELLANEOUS

**BINDING:** Have your "T.R.M." bound (including covers) in P.V.C. Leathercloth, dark blue, maroon, dark green; gold lettering; 12s. 6d. (P. & P. 3s., first volume). N. B. Wilkie, 58a, Craighart Gardens, Edinburgh 11.

Frenchman teaches French by tape recorder. Captivatingly vivid 1963 style lessons own home by post. (Also Spanish). To enrol write: R. de Breville, 22, University Street, Belfast, 7.

Recorder need repairing? Then let City and Essex Tape Recorder Centres do it for you expertly and economically. (See page 3).

## TAPE TO DISC

J. & B. RECORDINGS—"The Wedding Specialists." Tape to Disc. 60-minute LPs—unbeatable prices.—14, Willows Avenue, Morden, Surrey, Mitcham 9952.

JOHN HASSELL RECORDINGS. Tape to Disc. 50-minute LPs—Lowest prices. Studio and mobile services.—21, Nassau Road, London, S.W.13. Riverside 7150.

### TAPE TO DISC RECORDING

Reduced prices. Finest professional quality. 10-inch LP—35s. (32 mins.), 12-inch LP—40s. (45 mins.), 7-inch EP—17s. 6d.

### 48-HOUR POSTAL SERVICE

S.a.e for leaflet to Deroy Sound Service, 52, Hest Bank Lane, Hest Bank, Lancaster. Tel.: H.B. 2444.

TAPE-TO-DISC RECORDING SERVICE. All speeds. 50-minute LPs. Photographic sleeves with all recordings.—E.R.S., 162, Shirland Road, London, W.9.

## TAPE RECORDS

FOREIGN LANGUAGES ON TAPE from 38s. 6d. French, Italian, Spanish, German, Russian. Full money-back guarantee. — Details from Visaphone Co. Ltd., 28, Brookland Hill, London, N.W.11.

LEARN WHILE ASLEEP. Hypnotize with your recorder. Fascinating, educational. Astonishing details FREE!—Write: Sleep-Learning Research Association, Box 24-TE, Olympia, Washington, U.S.A.

PRE-RECORDED TAPES. Unique complete catalogue listing all makes, Mono, Stereo, 7 $\frac{1}{2}$  and 3 $\frac{1}{2}$  ips, including World Record Club tapes. Call for FREE copy or send 1s. mailing fee.—Dept. T.R.I., Teletape Ltd., 33, Edgware Road, W.2. PAD 1942.

TAPE RECORDINGS. World-famous hypnotist and Harley Street Psychoanalyst, W. J. Ousby (Instructional Recordings). Relaxation and self-hypnosis for increasing confidence, overcoming inferiorities, lessening nervous tension. Send name and address for list of Mr. Ousby's tape recordings. Details sent in plain envelope without obligation. W. J. Ousby, Home Farm Estate, Northchurch, Berkhamsted, Herts.

## TAPE EXCHANGES

Armchair Travel with "WORLDWIDE TAPE-TALK" . . . Britain's biggest and friendliest Tape Exchange. S.A.E. for particulars . . . 35, The Gardens, Harrow.

FRIENDLY FOLK ASSOCIATION, Torquay (Est. 1943). Social introductions, Pen-friends, Book-lovers, Stamps, Photography, Tapesponding. Members 100 Countries.

From "Down Under" the AUSTRALIAN TAPE RECORDISTS ASSOCIATION invites you to become a member of their World-Wide organisation. For details write P.O. Box 67, Eastwood, N.S.W. Australia.

Make interesting new friends UK and overseas, all ages. Join Victory Club, 34, Honeywell Road, London, S.W.11. Details free. Established 20 years.

Put your tape recorder to its most exciting use. Particulars, (S.A.E.) Secretary, International Tape Pals Incorporated, 101, Rotherview Road, Canklow, Rotherham, Yorkshire.

World Wide Collectors' Club. Members from 115 different countries. Pen and Tape pals, all ages. Quarterly journal 3s. 6d. (45 cents), yearly 20s. (3 dollars). Jimmy James, 54, Keslake Road, London, N.W.6, England.

## NEW EQUIPMENT

Ferrograph 5 A/N, 422 and 424, Revox E36, etc., always in stock. City and Essex Tape Recorder Centres. (See page 3).

REVOX LATEST F36, TELEFUNKEN SERIES 75, 85 and 95 AND TRUVOX SERIES 80 (LATEST 3 SPEED VERSIONS) always on demonstration and for immediate delivery at the hi-fi tape specialists. 48 hours' service for professional Tape Copying. N.R.S., 16, Kings College Road, London, N.W.3. PRI 3314.

STICKING TAPES? Not if you keep them in polythene TAPE PROTECTORS to guard against dampness and atmospheric change. Per dozen: 3 in.—1s. 6d.; 4 in.—1s. 8d.; 5 in.—1s. 9d.; 5 $\frac{1}{2}$  in.—2s.; 7 in.—2s. 4d.; 8 $\frac{1}{2}$  in.—2s. 8d. From your Dealer, or from SWAINS PACKAGING Ltd., Dept. 6, Buckhurst Hill, Essex.

TAPE RECORDERS. SAVE FROM 30 per cent to 60 per cent on the original price. Large stocks of second-hand, new, shop soiled machines. All guaranteed. Obtainable on our NO INTEREST TERMS. Best part exchange allowances on your existing equipment. CALL, WRITE, PHONE today for free list. Quotation and details. Our Mail Order covers the whole Country.—R. E. W. Earlsfield Ltd., 266, Upper Tooting Road, London, S.W.17. Balham 7710.

## MAGNETIC TAPE

Brand new P.V.C. recording tape. LP 5 $\frac{1}{2}$  in. 1200—14s. 6d. 7 in. 1800—21s. Postage 1s. 3d. each. McLuckic, 83, Loanhead, Coatbridge, Lanarkshire.

TAPE BARGAINS IN ALL SIZES. Example: Top Brand 5 $\frac{1}{2}$  in., 1,200 ft., 19s. 6d., P. & P., 1s. 3d. S.A.E. for list. Large choice of new and used recorders.—E. C. Kingsley & Co., 132, Tottenham Court Road, London, W.1. EUS 6500.

## Index to Advertisers

	Page
A. Brown & Sons Ltd. ....	11
Audio Electronics (Midlands) Ltd. ....	27
BASF Chemicals Ltd. ....	Back cover
Berean Forward Movement ....	22
C.B.S. International Ltd. ....	35
City & Essex Tape Recorder Centres ....	3
Educational Recordings Ltd. ....	22
Elstone Electronics Ltd. ....	4
E.M.I. Tape Ltd. ....	10
Fi-Cord Ltd. ....	21
Francis of Streatham ....	35
Gevaert Ltd. ....	5
Gramplan Reproducers Ltd. ....	35
Hansom Books Ltd. ....	22
Hi-Fi Centre ....	25
Highgate Acoustics ....	8
Howard Tape Recorders ....	28
International Audio Festival and Fair ....	9
Lee Electronics ....	25
Magnegraph ....	25
Minnesota Mining & Manufacturing Co. Ltd. ....	30
M.S.S. Recording Co. Ltd. ....	2
Multicore Solders Ltd. ....	6
Planet Projects Ltd. ....	22
Rapid Recording Service ....	27
Recording Machines Ltd. ....	26
REW Earlsfield Ltd. ....	11
Sheen Tape Recorder Centre Ltd. ....	25
Soundcraft Magnetics Ltd. ....	16
Stereoelectrics Ltd. ....	22
Tape Recorders (Bournemouth) Ltd. ....	26
Tape Recorder Centre (Halifax) ....	27
The Recorder Co. Ltd. ....	4
The Tape Recorder Centre Ltd. ....	7
Tysonic ....	27
University Cameras ....	26
Valradio Ltd. ....	6
Wellington Acoustic Laboratories Ltd. ....	22
Wharfedale Wireless Works Ltd. ....	6

# TAPE EXCHANGES

**T**APE recorder owners who wish to contact others with similar interests to exchange news and views by tape are invited to send their name, age, address, special hobby or interest for this section.

The details, given below, also include speeds and spool size to be used, name of recorder, and special areas to be contacted.

**Brook, Keith R.** (32). Pine Trees, Portsmouth, Essex, Surrey. Amateur radio, languages, music. 7½, 3½, 1½ ips. 7-inch spool. Philips EL 3542, two and four-track. **U.K., Holland**, German-speaking countries.

**Chambers, Maurice L.** (40). 139, Goldthorpe Avenue, Sheldon, Birmingham 25. Programme tape productions, music. 7½, 3½ ips. 7-inch spool. Ferrograph, Brenell, and Philips portable. **Japan, Malaya, Iraq.**

**Chandler, J. F.** (43). 4, Parliament Court, Parliament Hill, London, N.W.3. Photography, travel, music. 3½ ips. 5½-inch spool. Ferguson 441TR. **Asia, Africa, West Indies**, foreign residents in UK.

**Davies, Tony E.** (28). 71, Castleford Road, Sparkhill, Birmingham 11. Astronomy, classical music. 15, 7½, 3½, 1½ ips. 8-inch spool. Brenell Mk VM, Elizabethan Major. **Germany, USA, Canada, UK and Continent.**

**Dominguez, Manuel** (35). 65, Narbonne Avenue, London, S.W.4. Philately, short-wave radio. Letters first please. Spanish and English spoken.

**Dryden, John K.** (21). 1, Beaufort East, London Road, Bath, Somerset. Photography, caving, fishing, mountaineering. 7½, 3½, 1½, 15/16 ips. 7-inch spool. Philips EL3549.

**Foster, Peter** (24). Merchant Seaman, c/o 81, Norfolk Road, Cliftonville, Kent. Photography, travel, physique. 7½, 3½, 1½ ips. 7-inch spool. Grundig TK830 and Philips portable. Letters not required.

**Goldup, Don and Nina** (sister) (32). 5, Hillside, Southwick, Sussex. Angling, bird-song, music. 3½ ips. 5½-inch spool. Philips EL3541, four-track. Letters not required. Disabled of either sex welcome with view to contacting other similarly disabled persons.

**Hall, Donald** (21). 56a, Queensville, Staffordshire. Camping, pop and jazz music. 7½, 3½, 1½ ips. 5½-inch spool. Civic recorder. **USA, Australia, Canada.**

**Hills, G.** (48). Aldern Bridge House, Newbury, Berkshire. Stereo and mono music (not pop). 7½, 3½ ips. 5-inch spool. Sony Stereo 521, and Grundig TK24. **UK only.**

**Ireland, Michael J. F.** (25). "Willow Tree Cottage," North Street, Blofield, Norwich, Norfolk, NOR 842. Television, most music. 7½, 3½ ips. 7-inch spool. Truvox Mk IV, Grundig TK5 **UK and Commonwealth.**

**Leverett, Donald** (21). 19, Alexandra Terrace, Lincoln, Lincolnshire. Films, reading, Frank Sinatra, music. 3½ ips. 5½-inch spool. Grundig TK23 two or four-track.

**Ollier, Reg.** (42). 30, Crawley Avenue, Hebburn-on-Tyne, Co. Durham. Photography, travel, gardening, most sports, music. 3½ ips. 5½-inch spool. Grundig TK20 and TK1. **UK, USA, Germany, and Holland.**

**Palaniappan, L. S. P.** (35). 103, First Cross Street, Malacca, Malaya. German and Japanese languages, travel. 3½ ips. 7-inch spool. Philips EL3541, four-track.

**Parsons, Sheila Pamela** (26). 66, Kedlestone Drive, St. Mary Cray, Orpington, Kent. Theatre, ballet, swimming, painting, books, music (not pops). 3½ ips. 5½-inch spool. Ekco recorder. **Holland, New Zealand, S. America, Austria, Far East**, and anyone in Royal Navy.

**Pythian, Jack** (35). 54, Morley Street, Rochdale, Lancashire. Photography, travel, Johnny Mathis. 3½ ips. 5½-inch spool. Grundig TK23, Argyl Fidelity. Male contacts only.

**Marco, Donnini** (21). Via G. Donizette, 113, Prato, Italy. Folk lore, 1½ ips. 3½-inch spools. **UK.**

**Renzo, Tasselli** (20). Via dell'Arco, 11, Prato, Italy. Folk lore. 1½ ips. 3½-inch spools. **UK.**

**Sadler, G. W.** (64). 15a, Richmond Road, Ilford, Essex. Typography, theatre, books, organ and church music. 7½, 3½, 1½ ips. 7-inch spool. Telefunken Magnetophon 96. **UK or Germany.**

**Scholz, Dieter G.** (33). Mudener Strasse 1, Bremen 28, Germany. 3½, 1½ ips. 5½-inch spool. **UK.**

**Sculthorpe, Mrs. Ella.** R.R.I. Wellington, Vancouver Island, British Columbia, Canada. Salmon fishing, swimming, gardening, light music. 7½, 3½ ips. 5-inch spool. Female contacts only in **UK, New Zealand, Europe, USA, Canada.**

(Continued on page 34)

# ADVERTISEMENT INQUIRIES SERVICE

*This is a special service for readers of TAPE Recording Magazine. It enables you—without cost—to get fuller information about those products in which you are particularly interested. Fill in one coupon below for each inquiry, writing in your name and address in each case. Then cut out the whole of this section, following the dotted line, fold as indicated overleaf, and post to us.*

<p>I should like further information about the ..... of the ..... (product) mentioned on page.....of the ..... issue of TAPE Recording Magazine.</p> <p>NAME .....</p> <p>ADDRESS.....</p> <p style="text-align: right;">March 1963</p>	<p>I should like further information about the ..... of the ..... (product) mentioned on page.....of the ..... issue of TAPE Recording Magazine.</p> <p>NAME .....</p> <p>ADDRESS.....</p> <p style="text-align: right;">March 1963</p>
---	---

<p>I should like further information about the ..... of the ..... (product) mentioned on page.....of the ..... issue of TAPE Recording Magazine.</p> <p>NAME .....</p> <p>ADDRESS.....</p> <p style="text-align: right;">March 1963</p>	<p>I should like further information about the ..... of the ..... (product) mentioned on page.....of the ..... issue of TAPE Recording Magazine.</p> <p>NAME .....</p> <p>ADDRESS.....</p> <p style="text-align: right;">March 1963</p>
---	---

<p>I should like further information about the ..... of the ..... (product) mentioned on page.....of the ..... issue of TAPE Recording Magazine.</p> <p>NAME .....</p> <p>ADDRESS.....</p> <p style="text-align: right;">March 1963</p>	<h2 style="text-align: center;">BRITISH AMATEUR TAPE RECORDING CONTEST 1963</h2> <p>I have read the preliminary details regarding the British Amateur Tape Recording Contest 1963 and would like to receive full details and an entry form when published.</p> <p>NAME .....</p> <p>ADDRESS.....</p> <p style="text-align: right;">March 1963</p>
---	---

# Tape Exchanges

(Continued from page 33)

**Watling, Alan** (36). 29, Gordon Avenue, Thorpe, Norwich, Norfolk. World affairs. 3 $\frac{1}{2}$  ips. 5 $\frac{1}{2}$ -inch spool. Robuk RK3 and Philips EL3585. **Canada, USA and Europe.**

**White, Ken** (40). 21, Westholm, Letchworth, Hertfordshire. Music, cars, current affairs. 7 $\frac{1}{2}$ , 3 $\frac{1}{2}$  ips. 7-inch spool. Simon SP4. **UK, USA, Commonwealth.**

**White, Roy** (26). 1, Castle Avenue, Portadown, County Armagh. Astronomy, travel, preaching. 7 $\frac{1}{2}$ , 3 $\frac{1}{2}$  ips. 7-inch spool. Philips EL3541. **Continent and USA.**

## TEENAGE EXCHANGES

**Austin, Barry** (17). 68, Brittain Avenue, Chesterton, Newcastle, Staffordshire. Electronics, pop music. 3 $\frac{1}{2}$  ips. 3 $\frac{1}{2}$ -inch spool. Grundig TK1.

**Bassett, Leslie** (18). 56, Southroyd Park, Pudsey, Yorkshire. Photography, wrestling, chess, pop music. 3 $\frac{1}{2}$  ips. 5-inch spool. Philips recorder.

**Carr, Alan** (16). 34, Queens Street, Rhyope, Sunderland, Co. Durham. Pop music. 7 $\frac{1}{2}$ , 3 $\frac{1}{2}$ , 1 $\frac{1}{2}$  ips. 7-inch spool. Elizabethan LZ29. **Germany and Switzerland.**

**Craig, William** (18). 18, Caledonian Road, Edinburgh, Scotland. Photography, films, all music. 3 $\frac{1}{2}$  ips. 7-inch spool. Philips EL3541. Female contacts preferred.

**Creber, G.** (14). 14, Burrigge Avenue, Chelston, Torquay, Devon. Photography, pop music. 3 $\frac{1}{2}$  ips. 5-inch spool. Philips AG8109.

**Durkin, Eric John** (19). 103, Ritson Street, Lodge Lane, Liverpool 8, Lancashire. Tagistology, folk and trad jazz music. 7 $\frac{1}{2}$ , 3 $\frac{1}{2}$  ips. 8 $\frac{1}{2}$ -inch spool. Ferrograph recorder. **Scandinavia and Canada.**

**Fox, Stephen** (14). 33, Teviotdale Gardens, High Heaton, Newcastle-on-Tyne 7, Northumberland. Radio, television, pop music, cycling, travel, pets. 7 $\frac{1}{2}$ , 3 $\frac{1}{2}$ , 1 $\frac{1}{2}$  ips. 7-inch spool. Robuk RK3. Female contacts in N.E. England preferred.

**Gould, Keith** (19). "Woodcroft," Hughenden, High Wycombe, Buckinghamshire. Travel, campanology, motoring, psychiatry, music. 7 $\frac{1}{2}$ , 3 $\frac{1}{2}$ , 1 $\frac{1}{2}$  ips. 7-inch spool. Elizabethan FT3, Emidicta portable.

**Heere, Han** (20). Waalstraat 7911, Amsterdam, Holland. Psychology and English language. 7 $\frac{1}{2}$ , 3 $\frac{1}{2}$ , 1 $\frac{1}{2}$  ips. Female contacts in England preferred.

**Tscheshner, Klaus** (19). Holtwick/Kr. Coesfeld, (21a) Gartensteige 124, Germany. Modern literature and languages. 7 $\frac{1}{2}$ , 3 $\frac{1}{2}$ , 1 $\frac{1}{2}$  ips. 5 $\frac{1}{2}$ -inch spool. Telefunken 76K. **UK.**

**Keevil, David** (15). 6, Winsate Close, Middleton Hall Road, King's Norton, Birmingham 30. Photography, radio, pop music. 3 $\frac{1}{2}$  ips. 5 $\frac{1}{2}$ -inch spool. Argyll Fidelity Minor and Travler. Letters not required.

**Knight, Michael** (18). 220, Ringland Circle, Newport, Monmouthshire. Hi-fi, pop and classical music. 7 $\frac{1}{2}$ , 3 $\frac{1}{2}$ , 1 $\frac{1}{2}$  ips. 7-inch spool. Robuk RK3, Gramdeck and Walter 101.

**Leigh, Robert** (16). 3, Egerton Terrace, Altringham, Cheshire. Dancing, pop records. 3 $\frac{1}{2}$  ips. 5 $\frac{1}{2}$ -inch spool. H.M.V. recorder, four-track.

**Matthews, J. R.** (15). 66, Gordon Road, Chadwell Heath, Romford, Essex. Electronics, science fiction, most music, dancing. 3 $\frac{1}{2}$  ips. 5 $\frac{1}{2}$ -inch spool. Argyll Fidelity. French-speaking contacts required.

**McLeod, Robin, J. Y.** (18). The Gowans, Gowan Street, Arbroath, Angus. Travel, birds. 3 $\frac{1}{2}$  ips. 5 $\frac{1}{2}$ -inch spool. Grundig TK20. **France.**

**Meyer, Wolf-Ingo** (19). Vor dem Rothen Tor 1, 314, Lüneburg, Western Germany. English language. 3 $\frac{1}{2}$  ips. **UK.**

**Phillips, Carol Ann** (15). 23, Dunhurst Close, Westleigh, Havant, Hampshire. Badminton, pop and trad jazz music. 3 $\frac{1}{2}$  ips. 5 $\frac{1}{2}$ -inch spool. Grundig TK5. Male contacts preferred.

**Rickelmann, W.** (19). 7358 Haltern/Westfalen, Akazienweg 3, Germany. Literature, politics, cinema, dixieland and Ray Conniff music. 3 $\frac{1}{2}$  ips. 5 $\frac{1}{2}$ -inch spools. **England.**

**Rush, David** (14). 221, Netherton Road, Workson, Nottinghamshire. Modelling, pop and classical music. 3 $\frac{1}{2}$  ips. 5-inch spool. Philips Star-maker, four-track. **USA, Canada and Australia.**

**Somerfield, Ken.** (15). 58a, Dudley, Tipton, Staffordshire. Radio and pop music. 3 $\frac{1}{2}$  ips. 3-inch spool. Philips EL3541, four-track. Letters first please.

**Stoker, Chris** (19). Coton House, Churchover, Rugby, Warwickshire. Camping, rock-climbing, sports, pop music. 3 $\frac{1}{2}$  ips. 7-inch spool. Philips EL3541, four-track.

**Sweetman, Peter** (17). 21, The Byeways, Surbiton, Surrey. Economics, swimming, modern music. 3 $\frac{1}{2}$  ips. 3-inch spool. Grundig TK20. **Eire, Scotland, Holland.**

**Waghorn, Charles "Rusty"** (19). 12, Stoney Lane, Saltwells Estate, Netherton, near Dudley, Worcestershire. Travel, cars, pop music. 3 $\frac{1}{2}$  ips. 5 $\frac{1}{2}$ -inch spools. G.E.C. recorder.

FLAP B

SECOND FOLD HERE

POSTAGE  
WILL BE  
PAID BY  
PRINT AND  
PRESS  
SERVICES  
LIMITED

NO POSTAGE  
STAMP  
NECESSARY  
IF POSTED  
IN GREAT  
BRITAIN OR  
NORTHERN  
IRELAND

BUSINESS REPLY FOLDER  
Licence No. ND 922

TAPE RECORDING MAGAZINE

7 TUDOR STREET,  
LONDON, E.C.4.

THIRD FOLD HERE

FLAP A

FIRST FOLD ALONG THIS LINE

Fold along lines as indicated and then tuck Flap A into Flap B.

CUT ALONG DOTTED LINE



# CBS TAPES

BACKED BY WORLD-FAMOUS NAME IN SOUND

Specially prepared fine magnetic iron oxide dispersion; precision and uniformity in processing with quality control at all stages—these are features that result in CBS Tapes giving you extended frequency range, better wearing; better transients and the chance to make magnificent recordings from all sources even on quarter track at 3½ i.p.s.! Start using CBS now and note the difference!

IN ALL SIZES—STANDARD, LONG PLAY AND DOUBLE PLAY.

Particularly recommended for ¼ track and stereophonic use

## BETTER QUALITY FOR LESS COST

		5"	5½"	7"
STANDARD	1½ Mil	600' 17/6	900' 23/-	1200' 27/6
LONG PLAY	1 Mil	900' 21/-	1200' 25/-	1800' 35/-
DOUBLE PLAY	½ Mil	1200' 34/-	1800' 45/-	2400' 56/-
STANDARD MYLAR		600' 21/-	900' 28/-	1200' 35/-
LONG PLAY MYLAR		900' 25/-	1200' 32/-	1800' 47/-
DOUBLE PLAY MYLAR (Tensilised)		1200' 42/-	1800' 55/-	2400' 68/-

- ★ WITH LEADERS AND STOP FOILS
- ★ SUPERB QUALITY AT 3½ I.P.S.
- ★ LONG WEARING
- ★ RECOMMENDED SPECIALLY FOR FOUR TRACK INSTRUMENTS
- ★ CONSISTENTLY HIGH QUALITY IN ALL GRADES

## CBS TAPES

12-16 WATLING STREET,  
LONDON, E.C.4 CITY 2238



## The Grampian Ribbon Microphone

Exceptionally wide frequency response—virtually level from 40 c/s to 15 Kc/s—combined with excellent transient response, makes this the ideal instrument for the studio and wherever a high standard of fidelity is essential. Two models are available, each in three impedance sensitivities.

**Model GR. 1**, having a semi-cardioid response, gives approximately 10 db suppression to high frequencies at the rear face. It is ideal for overcoming problems of feed-back between microphone and speakers.

**Model GR. 2**, having a bi-directional "figure of eight" sensitivity pattern, discriminates against unwanted side noise both in the vertical and horizontal planes.

Supplied in attractive, padded instrument case, complete with 18 ft. screened lead, swivel holder and connector. £11.10.0.

**Grampian**

30 years' experience in  
the manufacture of high-  
quality microphones

A full range of accessories is available. Please send for illustrated leaflet. Enquire too for details of the famous Grampian DP4 range of Moving Coil Microphones  
**GRAMPIAN REPRODUCERS LTD**  
Hanworth Trading Estate, Feltham, Middlesex. FELtham 2657

# FRANCIS OF STREATHAM

Akai M6 Stereo ...	30 gns.	*Telefunken 85KL de	82 gns.
Akai M69 ...	79 gns.	luxe ...	59 gns.
*Brenell Mk. V. Model M	88 gns.	*Telefunken 95 ...	69 gns.
*Brenell Mk. V ...	64 gns.	*Telefunken 96 4 Tr. ...	95 gns.
Cossor 4 Tr. 1602 ...	38 gns.	*Telefunken 97 Stereo ...	95 gns.
Cossor 4 Tr. 1605 ...	62 gns.	*Telefunken 98 Stereo ...	39 gns.
Cossor 4 Tr. 1603 ...	28 gns.	Truvox Series 60, ¼ & ½ Tr.	55 gns.
Elizabethan Popular ...	24 gns.	Truvox Series 80/2 Tr. ...	59 gns.
Elizabethan LZ. 30 ...	32 gns.	Truvox Series 80/4 Tr. ...	82 gns.
Ferguson 3200 ...	26 gns.	Uher Universal ...	£93.13.0
Ferguson 3202 2Sp 4Tr ...	33 gns.	*Vortexion WVA ...	£110.3.0
*Ferrograph Series V ...	85 gns.	*Vortexion WVB ...	£148.10.0
*Ferrograph 422 or 424 ...	110 gns.	*Vortexion C Stereo ...	£160
Fidelity Argyll Minor ...	22 gns.	*Vortexion CBL ...	69 gns.
Grundig TK14 ...	35 gns.	*Wyndson International	
Grundig TK23 ...	45 gns.		
Grundig TK40 ...	75 gns.		
Grundig TK41 ...	75 gns.		
Grundig TK46 Stereo ...	99 gns.		
Loewe Opta 403 2Sp ...	45 gns.		
Loewe Opta 404 ...	53 gns.		
Philips 4 Tr. 3514 ...	27 gns.		
Philips 4 Tr. 3541 ...	36 gns.		
Philips 4 Tr. 3549 ...	62 gns.		
Philips new 4 Tr. Stereo	92 gns.		
*Reflectograph 'A' ¼ Tr.	105 gns.		
Robuk ...	36 gns.		
*Simon SP5 ...	93 gns.		
Sony Stereo 464 ...	75 gns.		
Sony ¼ and ½ Track 521 ...	124 gns.		
Stellaphon 4 Tr. 456 ...	28 gns.		
Stellaphon 4 Tr. 454 ...	38 gns.		
Stellaphon 4 Tr. 459 ...	62 gns.		
Stuzzi 4 Tr. Junior ...	26 gns.		
*Tandberg Series VI			
Stereo ¼ or ½ Tr. ...	110 gns.		
*Tandberg Series 7 ...	93 gns.		

### BATTERY PORTABLES

Philips Portable ...	24 gns.
*Butoba ...	66 gns.
Grundig TKI ...	29 gns.
Clarion Phonotrix ...	39 gns.
Fi-Cord 202 ...	66 gns.
Stella ...	25 gns.
Stuzzi Memo-Cord ...	25 gns.
Optacord 412 Batt/Mains	47 gns.
Uher 4000 ...	93 gns.
Cossor ...	25 gns.

\*Microphone extra

Mains Power Pack for  
Philips or Stella ... £5.0.0

TRUVOX Decks with Pre-Amps  
PD 82—Standard Twin Tr. £42.0.0  
PD 85—Professional 4 Tr. £52.10.0  
PD 86—Professional 4 Tr.  
Stereo ... £63.0.0  
Decks also Brenell and Wearite

## LEADING STOCKISTS OF EQUIPMENT FOR TAPE and HI-FI

... and NO EXTRA FOR CREDIT TERMS

- ★ Minimum Deposit
- ★ No Interest or Service Charges on H.P. up to 18 months
- ★ Free Service during Guarantee Period

Prices subject to alteration as announced  
by manufacturers

- Grampian Reflector... £5.15.0
- MICROPHONES & MIXERS  
Grampian Ribbon GR102 £10.15.0  
Grampian DP/4 Dynamic £8.0.0  
Lustraphone VR/70 Mini-  
ature Ribbon ... 10 gns.  
Lustraphone Ribbon ... £7.17.6  
Lustraphone LFV/59  
Dynamic ... £8.18.6  
Simon 'Cadenza' Ribbon £10.10.0  
Reslo Ribbon or Dynamic £12.6  
Reslo Cardioid ... £9.12.6  
Reslo Pencil Ribbon ... £8.0.0  
A.K.G. Stereo D.88 ... £19.19.0  
A.K.G. K.50 Headphones £7.10.0  
Grundig Mixer ... £16.16.0  
Microphones by ACOS, and  
TELEFUNKEN All Walgain  
Products. Brenell and Philips  
mixers.
- TAPES & ACCESSORIES  
Standard, Double Play, Long Play and  
Triple Play in all sizes by all leading  
makers.
- Pre-recorded Tapes by Columbia,  
H.M.V., Saga, Music on Tape, etc.  
Bib, Bond and Romagna splicers.  
Matching transformers. Plugs,  
sockets, etc.
- Defluxers by Walgain, Wearite.

### HI-FI DEPT.

- STEREO AND MONO  
AMPLIFIERS by  
Quad Scott Chapman  
Tripletone Walgain Leak  
Rogers Armstrong B. & O.
- TUNERS by  
Quad Rogers Chapman  
Leak Armstrong Pye
- LOUDSPEAKERS by  
Quad Philips  
W.B. Wharfedale  
Goodmans Tannoy  
Leak Lowther  
Kef
- MOTORS, PICKUPS, by  
Garrard Tannoy  
Garrard-Lenco Connoisseur  
Shure Stereo  
Philips Stereo  
B & O SME  
Ortofon Thorens

All types of Diamond and Sapphire  
styli, stereo and mono. Microlifts,  
Garrard SPG3, Acos Dust Bag.

- CABINETS Record Housing  
Design Furniture

Please note our only address as below

169-173 STREATHAM HIGH ROAD, LONDON, S.W.16

Between St. Leonard's Church  
and Streatham Station

STReatham 0446/0192

# 60

minutes per track of

## PRECISION SOUND RECORDING

at  $3\frac{3}{4}$ " i.p.s. on a  $4\frac{1}{4}$ " spool of



There are 1,200 ft. of BASF TRIPLE PLAY magnetic recording tape on a  $4\frac{1}{4}$ " spool. BASF, the pioneers of tape recording, produce the finest tapes in the world; now the revolutionary new TRIPLE PLAY TAPES give you three times more continuous playing time on 3", 4",  $4\frac{1}{4}$ " and 5" spools than Standard tapes. BASF TRIPLE PLAY TAPES are 0.0007" thin—surely the finest tapes ever made. They have been especially developed for portable and small spool recorders and of course, they retain all the superb qualities of all BASF Tapes—dimensional and magnetic stability, full frequency response, negligible print through and mirror finish surface.

BASF TRIPLE PLAY TAPES give small spool recorders big time potential



—SYMBOL OF AUTHENTIC SOUND

**BASF CHEMICALS LIMITED,**  
5a GILLESPIE ROAD, LONDON, N.5. TEL: CANONBURY 2011

To: **BASF CHEMICALS LIMITED**, 5a Gillespie Road, London, N.5  
Please put me on your Mailing List to receive a free copy of the BASF Newsletter containing information and topical articles on tape recording.

NAME .....

ADDRESS .....

TRM2 .....